

2015
V.1

Oklahoma State Department of Health

Hospital Based Outpatient Surgery Data

XML SUBMISSION MANUAL

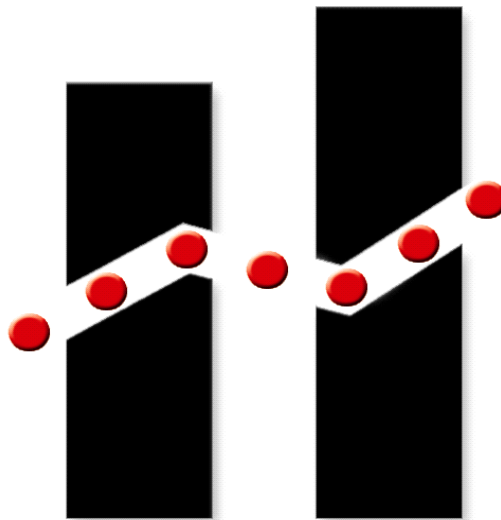

HEALTH CARE INFORMATION

1000 NE Tenth Street
Oklahoma City, OK 73117-1299
(405) 271-6225
chsadmin@health.ok.gov

AT A GLANCE:

Major highlights of the 2014 version of the Hospital Outpatient Surgery Data Manual

1. This manual is effective for data year 2015 issued in 2014.
2. New discharge dispositions were added, please see page 33 for new dispositions.
3. Data submissions are encouraged to be done on a monthly basis.
4. Three additional E-code fields were added.
5. Field lengthened for facility name, data contact city, city and primary and secondary payer.
6. ICD version indicator for each record to indicate which version of the coding classification systems will be used, please see page 40 for additional information.
7. Condition Codes were added as a new data element, page see page 34.
8. Value Codes were added as a new data element, please see page 49.
9. Detailed examples of Unknown, Homeless and Out of county patient addresses on pages 22 and 23.
10. Physician identifier to use when physician's NPI is unknown is OTH000.
11. Point of Origin code 7 was discontinued and replaced by condition code P7.
12. Medicare ID removed from individual records.
13. Data submission files should be unique to each physical location.
14. Schema Location was changed to
http://www.health.state.ok.us/datastds/outpatient_schema_2015.xsd
15. The upload process to our website has been changed slightly. There will be multiple schemas available during the upload process. The website will choose a schema based on the discharge dates the user enters in the "to and from dates" in the upload form. If the "to and from discharge dates" are not correct the file will fail the upload process.
16. On April 1, 2014, The Protecting Access to Medicare Act of 2014 was signed into law. Section 212 of the ACT delayed the adoption of ICD-10 standard code sets to not earlier than October 1, 2015.

On May 1, 2014, CMS announced that the U.S. Department of Health and Human Services expects to release an interim final rule in the near future that will include a new compliance date that would require the use of ICD-10 beginning October 1, 2015. The rule will also require HIPAA covered entities to continue to use ICD-9-CM through September 30, 2015.

Based on this notice, a tentative adoption date of October 1, 2015 has been used to FL 66-74a-e for illustrative purposes only (these are the diagnoses and procedures). This date is neither firm nor official since the IFR has not been released or finalized as of the publication date of the 2015 UB-04 Manual.

Table of Contents

Introduction	1
Data Confidentiality	1
Selection Criteria for Outpatient Surgery Records.....	1
Data Reporting Sources and Definitions	2
Data Submission Schedule	2
Follow-up for Noncompliance.....	3
Data Transfer Media	3
Editing and Validation.....	3
Facility Contacts.....	3
Data Transfer Format.....	4
TABLE 1 - Outpatient Surgery Data Elements	5
TABLE 2 – Data Elements Hierarchy.....	6
XML Data Record Sample	10
Description of Data Elements.....	15
TABLE 3 - Revenue Codes and Units of Service.....	51
Outpatient Code Editor	57

NOTICE

This Oklahoma Outpatient Surgery Data Reporting Manual, issued in September 2014, supersedes and replaces all previous versions. The XML format described in this manual will be the required format for data submissions for calendar year 2015 and forward. Please note that this manual reflects the changes associated with the UB-04 format. All major changes are listed on the front cover of this manual.

**If you have any questions regarding submission of this data, please contact:
Lou Ann Sanders at (405) 271-6225 or louanns@health.ok.gov**

If you would like to schedule a site visit at your facility, please contact Lou Ann Sanders at (405) 271-6225 and she will schedule a visit at your convenience.

Introduction

The Oklahoma Health Care Information System Act, defined in 63 O.S. (Supp. 1994) § 1-115 et seq., established the Division of Health Care Information (“Division”) in the Oklahoma State Department of Health. In accordance with the Act, the Division’s purpose is to develop and operate a system for collecting, processing and disseminating health care data. An integral component of the activities of the Division is the collection of outpatient surgery data. ***All facilities or related institutions that are licensed pursuant to Title 63 Section 1-701 et seq. of the Oklahoma Statutes are required to report information on outpatient surgery encounters.***

This manual defines the data that facilities are required by statute to submit to the Division. It specifies the technical requirements for data submission, defines the data elements to be submitted, and outlines the data editing procedure. In order to ensure the integrity of the database, data must be received in usable formats from all facilities. The Division will provide technical consultation and assistance upon request. This consultation or assistance is limited to activities that specifically enable the facility to submit data that will meet the requirements. The following sections provide a definition of the reporting source, the submission schedule, the preferred transfer method, the format and description of data elements to be transferred, and, finally, information about the editing/validation/error processing of the submitted data.

Data Confidentiality

Outpatient surgery data furnished to the Division are considered confidential under State law and are not public records as defined by the Open Records Act, Title 51 § 24A.1 et seq. Patient identifying information will not be disclosed. It will be used only for the creation and maintenance of anonymous medical case histories for statistical analysis and reports. The Division is prohibited from identifying, either directly or indirectly, any individual in its reports. The Division will not disclose individual patient identities in any manner, except as directed by a court of competent jurisdiction after an application showing good cause.

Selection Criteria for Outpatient Surgery Records

All outpatient surgery encounters that include records for open procedures, endoscopy procedures, catheterization procedures, pain management procedures, and injection procedures such as myelogram, arthrograms etc. One method to identify outpatient surgery records is by an outpatient bill type with a non-zero charge in revenue code categories 36X, 48X, 49X, 75X and 76X are to be submitted to the Division. Other criteria can be used as long as the desired results are met.

Data Reporting Sources and Definitions

Licensed hospital based and free standing hospital owned outpatient surgery facilities are the source for outpatient surgery data. **A data file must be submitted for each individual physical location of a facility regardless of how the facility is licensed.**

For each single outpatient surgery encounter a single data record shall be submitted. Each outpatient surgery data record shall consist of billing, medical, and personal information describing a patient, services received by the patient, and charges billed for the patient. The specific fields required are described in detail in the Data Elements Layout and Descriptions sections. Only one outpatient surgery data record should be submitted for each encounter. For a given patient, separate records for each bill generated should not be submitted, unless each bill represents a distinct outpatient surgery encounter. Procedures that are cancelled and never started should not be submitted.

Outpatient surgery data records should be submitted for persons who had an outpatient surgery encounter. If a patient is admitted as an inpatient after an outpatient encounter then no record should be submitted unless the outpatient record represents a distinct patient encounter separate from the inpatient stay.

A facility may submit outpatient surgery data directly to the Division or designate a submitting intermediary. Please note that each facility is responsible for the quality and completeness of its yearly submission, regardless of the utilization of a submitting intermediary. The Division will contact the institution directly for any necessary corrections or additional information. **When an intermediary is designated, the facility must still ensure that correct information is submitted in a timely manner. If a designated intermediary handles only a subset of a facility's encounters, then the facility must make separate arrangements to submit its other records (i.e., those not handled by the intermediary).**

For the purpose of communication and problem solving, each facility shall supply the Division with the name, telephone number, and job title of the person responsible for data submission from each facility.

Data Submission Schedule

For each calendar year of data collected, the Division must receive all Outpatient surgery data records by **March 1st following the close of that calendar year** (e.g. calendar year 2014 data must be submitted by March 1, 2015). Facilities are encouraged to submit on a monthly basis. Quarterly or semi-annual submissions are accepted as well. In all cases, data must be received by March 1st following each calendar year.

The data elements to be submitted are based on encounters occurring in a calendar year. A patient must be discharged within the calendar year to be included in the calendar year data set.

As described above, state mandated submissions are required annually however we are encouraging facilities to submit data on a more frequent monthly basis. Files submitted monthly will be due as soon after the month end is closed and the coding is complete but not to exceed 60 days past the end of the submission month.

Follow-Up for Non-Compliance

Submitting outpatient surgery data is required and is a condition of the facility's license as defined in Title 63 Section 1-701 et seq. Noncompliance, including incomplete reporting of required fields, will be referred to the Oklahoma State Department of Health Medical Facilities Division for follow-up and will be published as noncompliant in HCI reports.

Data Transfer Media

Secure Website Data Transfer

The method of data submission is through the Division's secure website. The website is accessible with a login and password.

The URL is: <https://www.phin.state.ok.us/chi-data/>

Instructions for submitting files on the website can be obtained from the Division.

EDITING AND VALIDATION

The Division will perform a variety of edits for quality assurance purposes and compliance with the specifications set forth in this submission manual. **Data submissions not meeting a 2% error tolerance level will be rejected. Also data files with critical field errors that have not been corrected to the 2% error threshold will also be rejected and your facility will be considered non-compliant.**

Before the deadline the facility can resubmit data until the files passes the criteria. Table I gives a list of the data fields and tolerance level for each of the field.

Hospitals are encouraged to review the data records for accuracy and completeness corresponding to these edits criteria prior to submission.

FACILITY CONTACTS

Facilities are encouraged to provide contact information for the following individuals:

Administrator

Data submission contact

Error correction contact

Vendor contact

Corporate contact (if applicable)

DATA TRANSFER FORMAT

The location of the xsd is:

http://www.health.state.ok.us/datastds/outpatient_schema_2015.xsd

Table 1 lists the data elements and the error tolerance level for each element. Table 2 describes the hierarchy of the data elements.

The headings used under Descriptions of Data Elements are:

Descriptive Data Element Name: Names commonly used to describe the fields.

XSD Data Type: Indicates field type such as string, positive integer, and date.

Element Name: The name that needs to be used for each field in the submitted file.

Accepts Null values: This line indicates whether null values are accepted.

Required in XSD: Indicates whether the field is required per the XML Schema Definition (XSD).

Minimum Constraint: Minimum number of characters allowed for the field.

Maximum Constraint: Maximum number of characters allowed for the field.

Definition: The definition specified for each data element is in general agreement with the definition specified for the field entry in the UB -04 manual. Facilities using data sources other than uniform billing should evaluate definitions and coding systems for agreement with those specified in this manual.

General Comments: Used in a similar manner as the UB-04 manual to provide additional information and guidelines for the reporting of the data element.

Edit: The criteria used by the Division to determine acceptability of the information provided.

UB-04 Form: Where applicable, this line identifies the document where the data elements can be found.

Locator: The location of the data element on the UB-04 form.

The data elements for each patient discharge are stored in a single record. No fillers are to be used between data fields.

Oklahoma Law (36 chapter 2 § 6581) has mandated that all hospital outpatient billing and claims submission use the UB-04 form.

Table 1
Outpatient Surgery Data Elements

DATA ELEMENT NAME	ERROR TOLERANCE LEVEL
Patient name	2%
Patient street address	-
Patient city	2%
Patient state	2%
Patient address postal code	2%
Patient date of birth	2%
Patient gender	2%
Patient social security number	-
Patient race	-
Patient ethnicity	-
Patient marital status	-
Patient control number	2%
Patient medical record number	-
National provider identifier	-
Admission date	2%
Admit hour	-
Discharge date	2%
Discharge Hour	-
Point of Origin	-
Priority of Admission	-
Patient discharge status	2%
Condition Code	-
External cause of injury I-6	-
Attending physician identifier	-
Facility assigned ambulatory patient classification APC (I-3)	-
Primary payer identifier	-
Primary payer name	-
Secondary payer identifier	-
Secondary payer name	-
Primary Payer classification	2%
Total charges for this encounter	2%
Type of Bill	2%
ICD version indicator	-
Principal diagnosis	2%
Other diagnosis codes (I-17)	2%
Principal procedure CPT code	2%
Principal procedure physician	-
Principal procedure date	-
Other procedure CPT codes I-5	2%
Other procedure physicians I-5	-
Other procedure code dates I-5	-
Total charges by revenue category	-
Units of service by revenue category	-
Value Code	-
Value Code Amount	-

Table 2

Data Elements Hierarchy

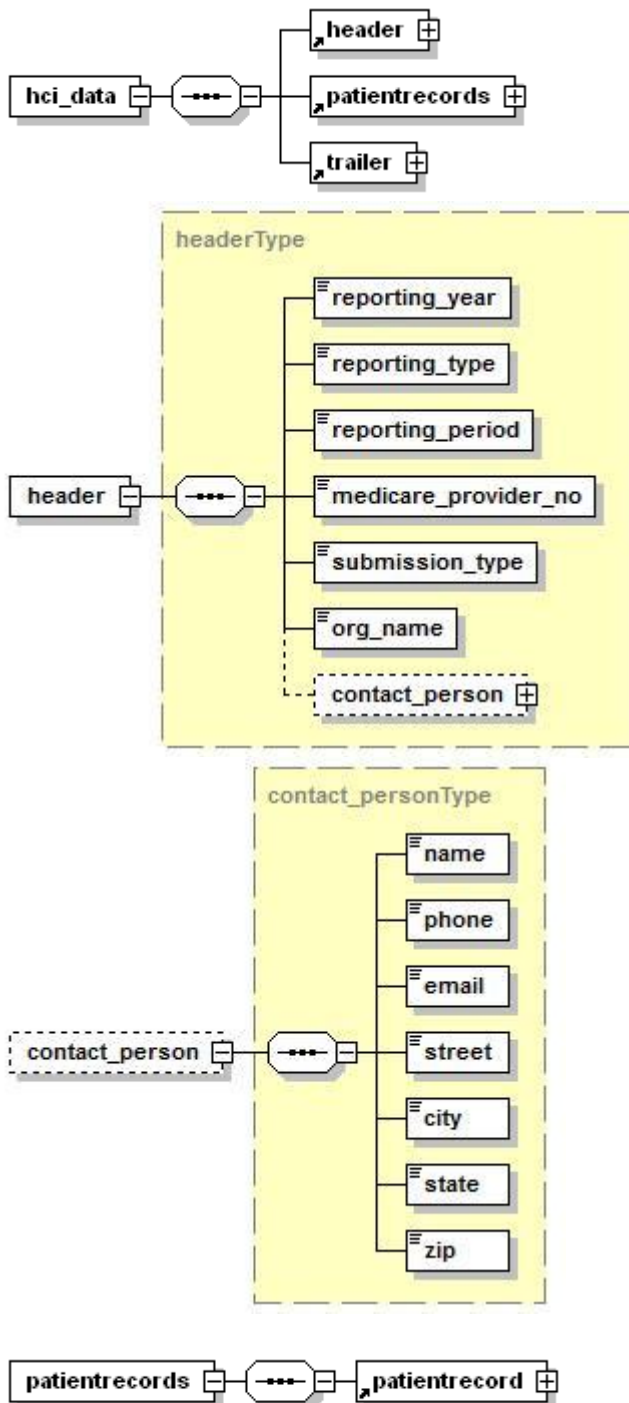

Data Elements Hierarchy Continued

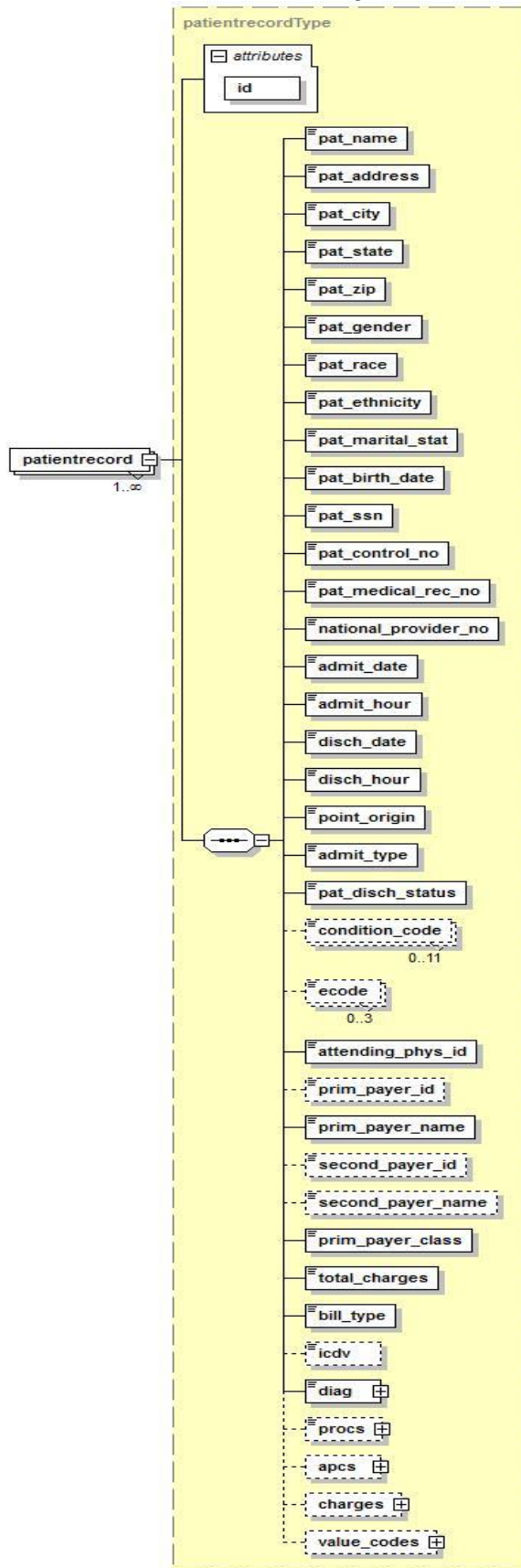

Data Elements Hierarchy Continued

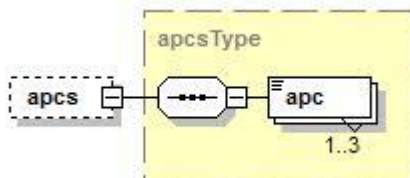
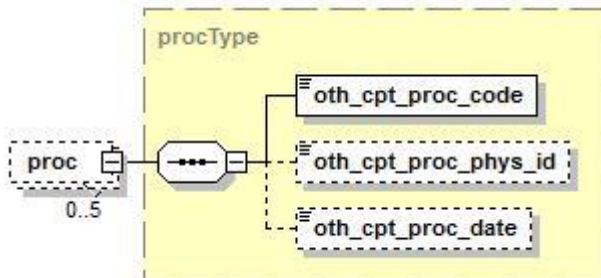
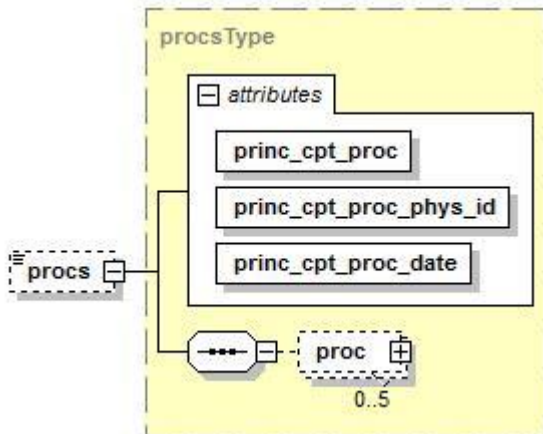
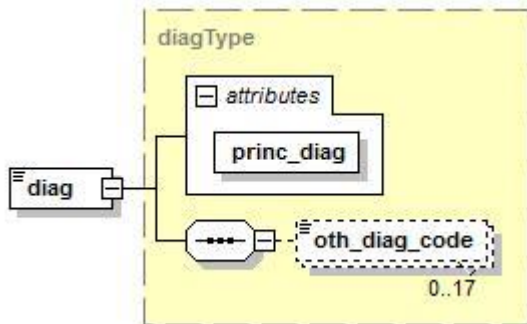

Data Elements Hierarchy Continued

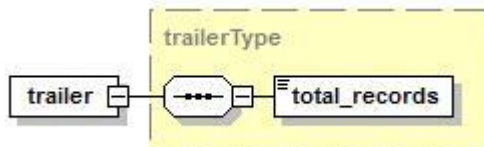
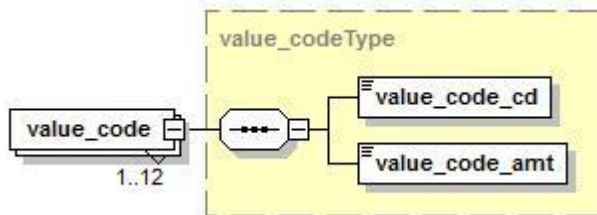
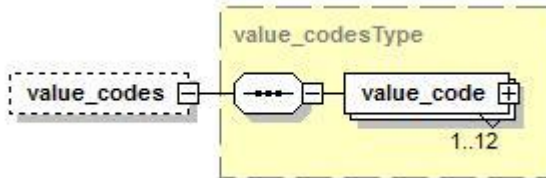
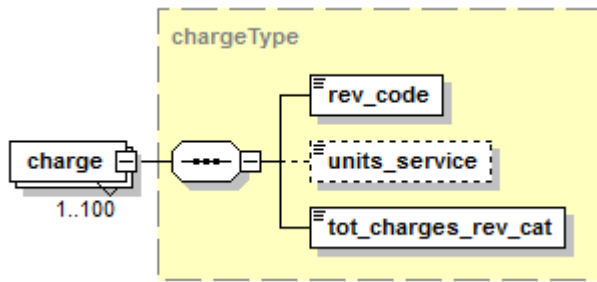
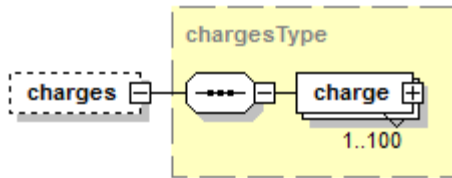

XML Data Record Sample

```
<?xml version="1.0" encoding="UTF-8" ?>
<hci_data xmlns:xsi="http://www.w3.org/2001/XMLSchema-instance"
xsi:noNamespaceSchemaLocation="http://www.health.state.ok.us/datatds/outpatient_schema_2
015.xsd">
<header>
  <reporting_year>2015</reporting_year>
  <reporting_type>2</reporting_type>
  <reporting_period>3</reporting_period>
  <medicare_provider_no>123456</medicare_provider_no>
  <submission_type>O</submission_type>
  <org_name>ABC Health Center</org_name>
<contact_person>
  <name>Contact Name</name>
  <phone>111-222-3333</phone>
  <email>webmail@ABCHealth.com</email>
  <street>Address 1 Address 2</street>
  <city>Oklahoma City</city>
  <state>OK</state>
  <zip>73000</zip>
</contact_person>
</header>
<patientrecords>
<patientrecord id="1">
  <pat_name>Doe, John</pat_name>
  <pat_address>123 Main st.</pat_address>
  <pat_city>Oklahoma City</pat_city>
  <pat_state>OK</pat_state>
  <pat_zip>73100</pat_zip>
  <pat_gender>M</pat_gender>
  <pat_race>4</pat_race>
  <pat_ethnicity>2</pat_ethnicity>
  <pat_marital_stat>S</pat_marital_stat>
  <pat_birth_date>2006-03-05</pat_birth_date>
  <pat_ssn>1234</pat_ssn>
  <pat_control_no>1236789</pat_control_no>
  <pat_medical_rec_no>456456</pat_medical_rec_no>
  <national_provider_no>1234567890</national_provider_no>
  <admit_date>2015-07-18</admit_date>
  <admit_hour>06</admit_hour>
  <disch_date>2015-07-18</disch_date>
  <disch_hour>18</disch_hour>
  <point_origin>2</point_origin>
  <admit_type>3</admit_type>
  <pat_disch_status>01</pat_disch_status>
  <condition_code>40</condition_code>
  <attending_phys_id>0987654321</attending_phys_id>
  <prim_payer_id>abcde1234567890</prim_payer_id>
  <prim_payer_name>Blue Cross</prim_payer_name>
  <second_payer_id>0123456789abcde</second_payer_id>
  <second_payer_name>Medicaid</second_payer_name>
  <prim_payer_class>1</prim_payer_class>
  <total_charges>3500</total_charges>

```

```

<bill_type>0131</bill_type>
<icdv>9</icdv>
= <diag princ_diag="47400">
  <oth_diag_code>3821</oth_diag_code>
  <oth_diag_code>78609</oth_diag_code>
</diag>
= <procs princ_cpt_proc="42820" princ_cpt_proc_phys_id="A123456789"
  princ_cpt_proc_date="2015-07-18">
  = <proc>
    <oth_cpt_proc_code>6942152</oth_cpt_proc_code>
    <oth_cpt_proc_phys_id>A123456789</oth_cpt_proc_phys_id>
    <oth_cpt_proc_date>2010-07-18</oth_cpt_proc_date>
  </proc>
</procs>
= <apcs>
  <apc>258</apc>
</apcs>
= <charges>
  = <charge>
    <rev_code>0490</rev_code>
    <tot_charges_rev_cat>1700</tot_charges_rev_cat>
  </charge>
  = <charge>
    <rev_code>0272</rev_code>
    <tot_charges_rev_cat>900</tot_charges_rev_cat>
  </charge>
  = <charge>
    <rev_code>0324</rev_code>
    <tot_charges_rev_cat>150</tot_charges_rev_cat>
  </charge>
  = <charge>
    <rev_code>0301</rev_code>
    <tot_charges_rev_cat>200</tot_charges_rev_cat>
  </charge>
  = <charge>
    <rev_code>0264</rev_code>
    <tot_charges_rev_cat>550</tot_charges_rev_cat>
  </charge>
</charges>
<value_codes>
  <value_code>
    <value_code_cd>54</value_code_cd>
    <value_code_amt>3629</value_code_amt>
  </value_code>
  <value_code>
    <value_code_cd>04</value_code_cd>
    <value_code_amt>167</value_code_amt>
  </value_code>
</value_codes>
</patientrecord>
= <patientrecord id="2">
  <pat_name>Sample, Sam</pat_name>
  <pat_address>111 First st.</pat_address>
  <pat_city>Norman</pat_city>

```

```

<pat_state>OK</pat_state>
<pat_zip>73090</pat_zip>
<pat_gender>M</pat_gender>
<pat_race>2</pat_race>
<pat_ethnicity>2</pat_ethnicity>
<pat_marital_stat>S</pat_marital_stat>
<pat_birth_date>1994-09-15</pat_birth_date>
<pat_ssn>111-22-3456</pat_ssn>
<pat_control_no>9876543</pat_control_no>
<pat_medical_rec_no>256455</pat_medical_rec_no>
<national_provider_no>1234567890</national_provider_no>
<admit_date>2015-08-20</admit_date>
<admit_hour>16</admit_hour>
<disch_date>2015-08-20</disch_date>
<disch_hour>23</disch_hour>
<point_origin>7</point_origin>
<admit_type>2</admit_type>
<pat_disch_status>01</pat_disch_status>
<ecode>E8261</ecode>
<ecode>E9352</ecode>
<attending_phys_id>1231231238</attending_phys_id>
<prim_payer_name>Self Pay</prim_payer_name>
<prim_payer_class>6</prim_payer_class>
<total_charges>3785</total_charges>
<bill_type>0131</bill_type>
<icdv>0</icdv>
= <diag princ_diag="81410">
  <oth_diag_code>7089</oth_diag_code>
</diag>
<procs princ_cpt_proc="25645" princ_cpt_proc_phys_id="987654321B"
  princ_cpt_proc_date="2015-08-20" />
= <apcs>
  <apc>0046</apc>
</apcs>
= <charges>
  = <charge>
    <rev_code>0490</rev_code>
    <tot_charges_rev_cat>2640</tot_charges_rev_cat>
  </charge>
  = <charge>
    <rev_code>0251</rev_code>
    <tot_charges_rev_cat>645</tot_charges_rev_cat>
  </charge>
  = <charge>
    <rev_code>0272</rev_code>
    <tot_charges_rev_cat>500</tot_charges_rev_cat>
  </charge>
</charges>
<value_codes>
  <value_code>
    <value_code_cd>54</value_code_cd>
    <value_code_amt>3629</value_code_amt>
  </value_code>
  <value_code>
    <value_code_cd>04</value_code_cd>
    <value_code_amt>167</value_code_amt>
  </value_code>

```



```

<value_code>
  <value_code_cd>10</value_code_cd>
  <value_code_amt>5896</value_code_amt>
</value_code>
</value_codes>
</patientrecord>
= <patientrecord id="3">
  <pat_name>Wendell, Oliver Douglas</pat_name>
  <pat_address>100 Green Acres</pat_address>
  <pat_city>Hooterville</pat_city>
  <pat_state>OK</pat_state>
  <pat_zip>73100</pat_zip>
  <pat_gender>M</pat_gender>
  <pat_race>4</pat_race>
  <pat_ethnicity>2</pat_ethnicity>
  <pat_marital_stat>M</pat_marital_stat>
  <pat_birth_date>1940-04-27</pat_birth_date>
  <pat_ssn>111-02-3333</pat_ssn>
  <pat_control_no>1237751</pat_control_no>
  <pat_medical_rec_no>456456</pat_medical_rec_no>
  <national_provider_no>1234123490</national_provider_no>
  <admit_date>2015-9-18</admit_date>
  <admit_hour>07</admit_hour>
  <disch_date>2015-9-18</disch_date>
  <disch_hour>14</disch_hour>
  <point_origin>2</point_origin>
  <admit_type>3</admit_type>
  <pat_disch_status>01</pat_disch_status>
  <condition_code>40</condition_code>
  <condition_code>05</condition_code>
  <attending_phys_id>3217612345</attending_phys_id>
  <prim_payer_id>abcab1234567890</prim_payer_id>
  <prim_payer_name>Medicare</prim_payer_name>
  <second_payer_id>0123456999abcde</second_payer_id>
  <second_payer_name>Medicaid</second_payer_name>
  <prim_payer_class>2</prim_payer_class>
  <total_charges>2984</total_charges>
  <bill_type>0131</bill_type>
  = <diag princ_diag="36610">
    <oth_diag_code>36500</oth_diag_code>
    <oth_diag_code>71509</oth_diag_code>
    <oth_diag_code>4019</oth_diag_code>
  </diag>
  <procs princ_cpt_proc="66983" princ_cpt_proc_phys_id="987612345B"
    princ_cpt_proc_date="2015-9-18" />
  = <apcs>
    <apc>0246</apc>
  </apcs>
  = <charges>
    = <charge>
      <rev_code>0490</rev_code>
      <tot_charges_rev_cat>1933</tot_charges_rev_cat>
    </charge>
    = <charge>
      <rev_code>0272</rev_code>
      <tot_charges_rev_cat>400</tot_charges_rev_cat>
    </charge>
  </charges>
</patientrecord id="3">

```

```
    = <charge>
      <rev_code>0301</rev_code>
      <tot_charges_rev_cat>351</tot_charges_rev_cat>
    </charge>
  = <charge>
    <rev_code>0264</rev_code>
    <tot_charges_rev_cat>300</tot_charges_rev_cat>
  </charge>
</charges>
</patientrecord>
</patientrecords>
= <trailer>
  <total_records>3</total_records>
```

Description of Data Elements

Data Elements

hci_data/Header

Total Elements: 6+1(1 element has child element)

Element Name: reporting_year, reporting_type, reporting_period, medicare_provider_no, submission_type, org_name

Data Element with child element: contact_person

Descriptive Data Element Name: Reporting Year

XSD Data Type: xs:string

Element Name: reporting_year

Accepts Null values: No

Required in XSD: Yes

Minimum Constraint: 4

Maximum Constraint: 4

Definition: The calendar year in which the patients were discharged.

Comments: Use the four-digit year format YYYY
E.g. 2015

Edit: A valid year must be present

Not a UB-04 field

Descriptive Data Element Name: Reporting Type

XSD Data Type: xs:string

Element Name: reporting_type

Accepts Null values: No

Required in XSD: Yes

Minimum Constraint: 1

Maximum Constraint: 1

Definition: The portion of time that will cover the data submitted.

Comments: This field needs to have one of the following entries:

- 1 – Yearly
- 2 – Quarterly
- 3 – Monthly

Edit: Reporting type needs to be valid.

Not a UB-04 field

Descriptive Data Element Name: Reporting Period

XSD Data Type: xs:string

Element Name: reporting_period

Accepts Null values: No

Required in XSD: Yes

Minimum Constraint: 1

Maximum Constraint: 2

Definition: The period for which the patients were discharged.

Comments: Complete this field, if submitting data annually, quarterly or monthly.

For Reporting Type=1, Use 1 for Reporting Period, if submitting annually

For Reporting Type=2

Use the following numbers for Reporting Period

1 for First quarter (Jan, Feb and March)

2 for Second quarter (April, May and June)

3 for third quarter (July, Aug and Sept)

4 for quarter (Oct, Nov and Dec)

For Reporting Type=3

Use the following numbers for Reporting Period

1,2,3... 12 to denote Jan, Feb, Mar... Dec.

If submitting multiple months or quarters a separate file for each period must be submitted.

Edit: The period needs to be valid.

Not a UB-04 field

Descriptive Data Element Name: Medicare Provider Number

XSD Data Type: xs:string

Element Name: medicare_provider_no

Accepts Null values: No

Required in XSD: Yes

Minimum Constraint: 6

Maximum Constraint: 15

Definition: The number assigned to the facility by Center for Medicare and Medicaid Services. Tax ID number can be used if the facility does not have a Medicare ID.

Edit: Number must be valid.

Currently not a UB-04 field.

Descriptive Data Element Name: Type of Data Submission

XSD Data Type: xs: string

Element Name: submission_type

Accepts Null values: No

Required in XSD: Yes

Minimum Constraint: 1

Maximum Constraint: 1

Definition: Indicates the type of data submitted.

Comments: Use the following to indicate the types of data:

O - Hospital Outpatient Surgery Data

Edit: Must be a valid entry

Not a UB-04 field

Descriptive Data Element Name: Name of the Hospital

XSD Data Type: xs: string

Element Name: org_name

Accepts Null values: No

Required in XSD: Yes

Minimum Constraint: 5

Maximum Constraint: 60

Definition: The name of the facility for which the data is submitted.

Comments: The name must be abbreviated if length is more than 60 characters.

Edit: Must be a valid entry

UB-04 FL I

Data Elements

contact_person

Total Elements: 7

Element Name: name, phone, email, street, city, state, zip

Descriptive Data Element Name: Name of the Data Submission Contact

XSD Data Type: xs: string

Element Name: name

Accepts Null values: No

Required in XSD: Yes

Minimum Constraint: 5

Maximum Constraint: 30

Definition: Name of the person submitting the data.

Edit: Must be a valid entry.

Not a UB-04 field

Descriptive Data Element Name: Phone Number

XSD Data Type: xs: string

Element Name: phone

Accepts Null values: No

Required in XSD: Yes

Minimum Constraint: 12

Maximum Constraint: 12

Definition: Telephone number of the data submission contact.

Comments: The phone number must be in the following format:

111-222-3333

Edit: Must be a valid phone number.

Not a UB-04 field

Descriptive Data Element Name: Email

XSD Data Type: xs: string

Element Name: email

Accepts Null values: No

Required in XSD: Yes

Minimum Constraint: 5

Maximum Constraint: 50

Definition: Email address of the data submission contact.

Edit: Must be a valid email address.

Not a UB-04 field

Descriptive Data Element Name: Street

XSD Data Type: xs: string

Element Name: street

Accepts Null values: No

Required in XSD: Yes

Minimum Constraint: 5

Maximum Constraint: 70

Definition: The street address of the data submission contact.

Comment:

- Use mailing address if different than physical address.
- Address can be that of the hospital, corporation location etc.

Edit: Must be a valid address.

Not a UB-04 field

Descriptive Data Element Name: City

XSD Data Type: xs: string

Element Name: city

Accepts Null values: No

Required in XSD: Yes

Minimum Constraint: 3

Maximum Constraint: 40

Definition: The city of the data submission contact's street address.

Edit: Must be a valid city.

Not a UB-04 field

Descriptive Data Element Name: State

XSD Data Type: xs: string

Element Name: state

Accepts Null values: No

Required in XSD: Yes

Minimum Constraint: 2

Maximum Constraint: 2

Definition: The State of the data submission contact's address.

Comments: Use standard Post Office state abbreviations (e.g. OK for Oklahoma, TX for Texas).

Edit: State abbreviation must be present and valid.

Not a UB-04 field

Descriptive Data Element Name: Zip

XSD Data Type: xs: string

Element Name: zip

Accepts Null values: No

Required in XSD: Yes

Minimum Constraint: 5

Maximum Constraint: 10

Definition: The zip code of the data submission contact's address.

Comments: Nine-digit zip codes are encouraged in the form XXXXX-YYYY or XXXXXYYYY

Edit: Must be a valid zip code.

Not a UB-04 field

Data Elements **hci_data/patientrecords/patientrecord**

Total Attribute: 1

Total Elements: 32 + 5 (5 elements have child elements)

Attribute Name: id

Element Name: pat_name, pat_address, pat_city, pat_state, pat_zip, pat_birth_date, pat_gender, pat_ssn, pat_race, pat_ethnicity, pat_marital_stat, pat_control_no, pat_medical_rec_no, national_provider_no, admit_date, admit_hour, disch_date, disch_hour, point_origin, admit_type, pat_disch_status, condition_code, ecode (up to 6), attending_phys_id, prim_payer_id, prim_payer_name, second_payer_id, second_payer_name, prim_payer_class, total_charges, bill_type, icdv

Data Elements with child elements: diag, procs, apcs, charges and value_code

Descriptive Data Element Name: Sequential Record Number

XSD Data Type: xs:positiveInteger

Attribute Name: id

Accepts Null values: No

Required in XSD: Yes

Minimum Constraint: 1

Maximum Constraint: 6

Definition: A sequential record number generated for each record in the file beginning with one (1).

Comments: Should reflect the count of all records submitted.

Edit: Must be valid.

Not a UB-04 field

Descriptive Data Element Name: Patient Name

XSD Data Type: xs:string

Element Name: pat_name

Accepts Null values: No

Required in XSD: Yes

Minimum Constraint: 2

Maximum Constraint: 30

Definition: Last name, first name, and middle initial of the patient.

Comments: Use a comma and one space to separate last and first names. No space should be left between a prefix and a name (e.g. McCauley, DeClair, or VonFeldt). Titles such as Sir, Msgr., and Dr. should not be recorded. No special characters (e.g. (), *, **, /) should be included in the name. Record hyphenated names with the hyphen (e.g. Smith-Jones, Rebecca). To record a suffix of a name, write the last name, leave a space, and then write the suffix. Follow the suffix with a comma and a first name. For example: Jones II, Robert or Adams Jr., Fred. The middle initial should include only one character. Comments such as 'deceased', 'test' are not valid names and should not be reported as such.

Edit: Name must have a comma and space separating the last name from the first.

UB-04 FL 8

Descriptive Data Element Name: Patient Street Address

XSD Data Type: xs:string

Element Name: pat_address

Accepts Null values: No

Required in XSD: Yes

Minimum Constraint: 5

Maximum Constraint: 70

Definition: The Street address of the patient's residence. P.O. Boxes and Rural Routes should only be used when the physical address is not available.

Comments: The street address should include the following where applicable:

- Street number
- Street direction e.g. N, NW, SW, SE etc.
- Street name
- Street type e.g. Avenue, St, Rd, Road, CT, etc. Refer to the link for commonly used street suffixes http://pe.usps.com/text/pub28/28apc_002.htm
- Apartment number
- Homeless patient's address should be reported "Homeless".
- Out-of Country patient's address should indicate the Country of Origin such as Spain, Mexico, etc.
- If the address is unknown then the address should be reported as "Unknown".

Edit: Street address must be present. Comments such as 'DHS custody', 'return mail', 'deceased', 'Estate of', names of Nursing homes etc. are not valid addresses and should not be reported in the data as such.

UB-04 FL9a

Descriptive Data Element Name: Patient City

XSD Data Type: xs:string

Element Name: pat_city

Accepts Null values: No

Required in XSD: Yes

Minimum Constraint: 3

Maximum Constraint: 40

Definition: The city of the patient's street address.

Comments: The city of the patient should include the following where applicable

- Abbreviations are not accepted.
- City must be spelled out in full. E.g. Saint Louis, Fort Gibson etc.
- Homeless patients and patients with an unknown address should report city as the name of the city where the hospital is located such as Tulsa, Elk City, Edmond, etc.
- Out-of country patient's city should be reported as "Out of Country".

Edit: Valid city must be present.

UB-04 FL9b

Descriptive Data Element Name: Patient State

XSD Data Type: xs:string

Element Name: pat_state

Accepts Null values: No

Required in XSD: Yes

Minimum Constraint: 2

Maximum Constraint: 2

Definition: The state of the patient's address.

Comments: The state of the patient address should include the following where applicable

- Use standard Post Office state abbreviations (e.g. OK for Oklahoma, TX for Texas).
- Homeless patients and patients with an unknown state should be reported as "ZZ".
- Out-of Country patient's state should be reported as "XX".

Edit: State abbreviation must be present and valid.

UB-04 FL 9c

Descriptive Data Element Name: Patient Address Postal Code

XSD Data Type: xs:string

Element Name: pat_zip

Accepts Null values: No

Required in XSD: Yes

Minimum Constraint: 5

Maximum Constraint: 10

Definition: The zip code of the patient's address.

Comments: The zip code of the patient should include the following where applicable

- Nine-digit zip codes are encouraged in the form XXXXX-YYYY or XXXXXYYYY.
- Homeless patients and patients with an unknown zip code should be reported as "99990".
- Out-of Country patient's zip code should be reported as "99999".

Edit: Postal zip code must be present and valid and consistent with patient's state.

UB-04 FL 9d

Descriptive Data Element Name: Patient Gender

XSD Data Type: xs:string

Element Name: pat_gender

Accepts Null values: No

Required in XSD: Yes

Minimum Constraint: 1

Maximum Constraint: 1

Definition: Patient gender as recorded at the time of admission or start of care.

Comments: This is a one-character code:

M = Male

F = Female

U = Unknown

Edit: Code must be valid and consistent with diagnosis and procedure codes.
Unknown gender above 2% is considered an error.

UB-04 FL 11

Descriptive Data Element Name: Patient Race

XSD Data Type: xs:positiveInteger

Element Name: pat_race

Accepts Null values: No

Required in XSD: Yes

Minimum Constraint: 1

Maximum Constraint: 1

Definition: This item gives the race of the patient. The information is based on self-identification and is to be obtained from the patient, a relative, or a friend. The facility is **not** to categorize the patient based on observation or personal judgment.

Comments: If the patient chooses not to answer, the facility should enter the code for unknown. If the facility fails to request the information the hospital should enter the code for unknown.

1 = American Indian or Alaskan Native

Definition: A person having origins in any of the original peoples of North and South America (including Central America or other Spanish cultural origin), and who maintains tribal affiliation or community attachment.

2 = Asian or Pacific Islander

Definition: A person having origins in any of the original peoples of the Far East, Southeast Asia, or the Indian subcontinent, Hawaii, Guam, Samoa, or other Pacific Islands (including Central America or other Spanish cultural origin), including, for example, Bangladesh, Cambodia, China, India, Japan, Korea, Malaysia, Pakistan, the Philippine Islands, Sri Lanka, Thailand, and Vietnam

3 = Black

Definition: A person having origins in any of the black racial groups of Africa (including Central America or other Spanish cultural origin). It includes people who indicate their race as 'Black, African American, Afro American, Kenyan, Nigerian, or Haitian

4 = White

Definition: A person having origins in any of the original Caucasian peoples of Europe, North Africa or the Middle East (including Central America or other Spanish cultural origin). It includes people who indicate their race as 'White' or report entries such as Irish, German, Italian, Lebanese, Near Easterner, Arab, or Polish

5 = Other

Definition: Any possible options not covered in the above categories.

6 = Unknown

Definition: A person who chooses not to answer the question or the hospital fails to request the information.

Edit: Code must be valid.
Currently not a UB-04 field

Descriptive Data Element Name: Patient Ethnicity

XSD Data Type: xs: positiveInteger

Element Name: pat_ethnicity

Accepts Null values: No

Required in XSD: Yes

Minimum Constraint: 1

Maximum Constraint: 1

Definition: This item gives the **Patient's answer to the question "Are you Hispanic?"**. The information is based on self-identification and is to be obtained from the patient, a relative or a friend. The facility is **not** to categorize the patient based on observation or personal judgment.

Comments: If the patient chooses not to answer, the facility should enter the code for unknown. If the facility fails to request the information, the hospital should enter the code for unknown.

1 = Hispanic origin or Latino

Definition: A person of Mexican, Puerto Rican, Cuban, Central or South American, or other Spanish cultural origin, regardless of race.

2 = Not of Hispanic origin or Latino

Definition: A person who is not classified in 1.

6 = Unknown

Definition: A person who chooses not to respond to the inquiry.

Edit: Code must be valid.
Currently not a UB-04 field.

Descriptive Data Element Name: Patient Marital Status

XSD Data Type: xs:string

Element Name: pat_marital_stat

Accepts Null values: No

Required in XSD: Yes

Minimum Constraint: 1

Maximum Constraint: 1

Definition: The marital status of the patient at date of admission.

Comments: One-character code, where:

S = Single
M = Married
P = Life Partner
X = Legally separated
D = Divorced
W = Widowed
U = Unknown

Edit: Code must be valid.

Currently not a UB-04 field.

Descriptive Data Element Name: Patient Date of Birth

XSD Data Type: xs:date

Element Name: pat_birth_date

Accepts Null values: No

Required in XSD: Yes

Minimum Constraint: 10

Maximum Constraint: 10

Definition: The date of birth of the patient.

Comments: Use the ten-digit format YYYY-MM-DD where:

- MM is the month in two digits ranging from 01 to 12
- DD is the day in two digits ranging from 01 to 31
- YYYY is the year of birth in four digits.

Edit: Date of birth must be:

- Present
- A valid date- not occurring after admit or discharge date
- Equal to admit date for hospital newborns (Principal diagnosis V30-V39 except V30.1)
- Consistent with diagnosis
- Age calculated from date of birth and discharge and must be less than 125 years

UB-04 FL 10

Descriptive Data Element Name: Patient Social Security Number

XSD Data Type: xs:string

Element Name: pat_ssn

Accepts Null values: No

Required in XSD: Yes

Minimum Constraint: 3

Maximum Constraint: 12

Definition: The last 4 digits of the Social Security Number of the patient receiving care.

Comments: If reporting the complete SSN hyphens can be used but are not required. If a patient does not have a Social Security Number, use the following codes:

- For a newborn use the last 4 digits of the Mother's SSN + 100 (e.g., 6789100) for a single birth who has not obtained a SSN. For multiple births use the last 4 digits of the Mother's SSN + 101 for Baby A and SSN + 102 for Baby B, etc.
- Newborns whose mother's SSN is unknown should be reported as 200100 for the single newborn, for multiple births use 200101 for Baby A, 200102 for Baby B
- 200 for a patient who has no SSN. This is not to be used as the SSN for a newborn.
- 300 for a patient who chooses not to provide his/her SSN. This is not to be used as the SSN for a newborn.

Edit: Entry must be a valid SSN, or 200 or 300.

Currently not a UB-04 field.

Descriptive Data Element Name: Patient Control Number

XSD Data Type: xs:string

Element Name: pat_control_no

Accepts Null values: No

Required in XSD: Yes

Minimum Constraint: 2

Maximum Constraint: 17

Definition: A code assigned by the facility uniquely identifying individual discharge events.

Comments:

- This code will be used for reference in correspondence, problem solving, edit corrections and return of grouped data.
- The PCN identifies a single facility visit for a patient and may be called or defined as an account number.
- The PCN is different from the medical record number, which identifies an individual patient and remains the same through multiple facility visits.

Edit: PCN code must be present and should be unique within a facility.

UB-04 FL 3a

Descriptive Data Element Name: Patient Medical Record Number

XSD Data Type: xs: string

Element Name: pat_medical_rec_no

Accepts Null values: No

Required in XSD: Yes

Minimum Constraint: 2

Maximum Constraint: 17

Definition: A unique identifier assigned by the facility to the patient's medical/health record at the first admission and used for all subsequent admissions.

Edit: MRN code must be present and should represent a unique patient.

UB-04 FL 3b

Descriptive Data Element Name: National Provider Number

XSD Data Type: xs: string

Element Name: national_provider_no

Accepts Null values: No

Required in XSD: Yes

Minimum Constraint: 10

Maximum Constraint: 10

Definition: The ten-digit number assigned to the facility as a result of HIPAA's National Provider Identifier (NPI) regulations.

Edit: Number must be valid and match the CMS national provider list.

Currently not a UB-04 field.

Descriptive Data Element Name: Admission Date

XSD Data Type: xs:date

Element Name: admit_date

Accepts Null values: No

Required in XSD: Yes

Minimum Constraint: 10

Maximum Constraint: 10

Definition: The date the patient was admitted to the facility.

Comments: Admission date has a 10 digit format YYYY-MM-DD where:

- MM is the month in two digits ranging from 01 to 12
- DD is the day in two digits ranging from 01 to 31
- YYYY is the year in four digits (e.g. 2008)

Edit: Admission date must be:

- Present and valid.
- No earlier than the date of birth.
- No later than discharge date.

UB-04 FL 12

Descriptive Data Element Name: Admit Hour

XSD Data Type: xs: Integer

Element Name: admit_hour

Accepts Null values: No

Required in XSD: Yes

Minimum Constraint: 2

Maximum Constraint: 2

Definition: The hour during which the patient was admitted for outpatient care.

Comments: Admit hour is a 2-digit format with the following structure:

Code	Time – AM	Code	Time - PM
00	12:00 – 12:59 Midnight	12	12:00–12:59 Noon
01	01:00 – 01:59	13	01:00 – 01:59
02	02:00 – 02:59	14	02:00 – 02:59
03	03:00 – 03:59	15	03:00 – 03:59
04	04:00 – 04:59	16	04:00 – 04:59
05	05:00 – 05:59	17	05:00 – 05:59
06	06:00 – 06:59	18	06:00 – 06:59
07	07:00 – 07:59	19	07:00 – 07:59
08	08:00 – 08:59	20	08:00 – 08:59
09	09:00 – 09:59	21	09:00 – 09:59
10	10:00 – 10:59	22	10:00 – 10:59
11	11:00 – 11:59	23	11:00 – 11:59
99	Hour Unknown		

Edits: Valid hour must be present.

UB-04 FL 13

Descriptive Data Element Name: Discharge Date

XSD Data Type: xs:date

Element Name: disch_date

Accepts Null values: No

Required in XSD: Yes

Minimum Constraint: 10

Maximum Constraint: 10

Definition: The date the patient was discharged from the facility.

Comments: Discharge date is in a ten digit format YYYY-MM-DD where:

- MM is the month in two digits ranging from 01 to 12
- DD is the day in two digits ranging from 01 to 31
- YYYY is the year of discharge (e.g. 2008)

Edit: Discharge date must be:

- Present and Valid
- No earlier than admission date
- No earlier than date of birth

UB-04 FL 6

Descriptive Data Element Name: Discharge Hour

XSD Data Type: xs: Integer

Element Name: disch_hour

Accepts Null values: No

Required in XSD: Yes

Minimum Constraint: 2

Maximum Constraint: 2

Definition: The hour during which the patient was discharged from outpatient care .

Comments: Discharge hour is a 2-digit format with the following structure:

Code	Time – AM	Code	Time - PM
00	12:00 – 12:59	12	12:00–12:59
	Midnight		Noon
01	01:00 – 01:59	13	01:00 – 01:59
02	02:00 – 02:59	14	02:00 – 02:59
03	03:00 – 03:59	15	03:00 – 03:59
04	04:00 – 04:59	16	04:00 – 04:59
05	05:00 – 05:59	17	05:00 – 05:59
06	06:00 – 06:59	18	06:00 – 06:59
07	07:00 – 07:59	19	07:00 – 07:59
08	08:00 – 08:59	20	08:00 – 08:59
09	09:00 – 09:59	21	09:00 – 09:59
10	10:00 – 10:59	22	10:00 – 10:59
11	11:00 – 11:59	23	11:00 – 11:59
99	Hour Unknown		

Edits: Valid hour must be present.

UB-04 FL 16

Descriptive Data Element Name: Point of Origin

XSD Data Type: xs: string

Element Name: point_origin

Accepts Null values: No

Required in XSD: Yes

Minimum Constraint: 1

Maximum Constraint: 1

Definition: A code indicating the point of patient origin for the admission

Comments: This single digit code depends on the code entered for Type of Admission. If Type of Admission is 1 (emergency), 2 (urgent), 3 (elective) or 5 (trauma center), points of origin codes have different meanings than when Type of Admission is 4, (newborn).

Point of Origin codes for Priority (Type) of Admission= Emergency (1), Urgent (2), Elective (3) Trauma Center (5):

1 = Nonhealthcare Facility Point of Origin

Definition: The patient presents to this facility with an order from a physician for services or for a nonemergent self-referral.

2 = Clinic

Definition: The patient was referred to this facility from a freestanding or nonfreestanding clinic for outpatient or referenced diagnostic services.

4 = Transfer from a hospital (Different Facility)

Definition: The patient was transferred to this facility as an outpatient from an acute care facility. This excludes transfers from hospital inpatient in the same facility.

5 = Transfer from a Skilled Nursing Facility or Intermediate Care Facility

Definition: The patient was referred to this facility for outpatient or referenced diagnostic services from a SNF or ECF where he or she was a resident.

6 = Transfer from another health care facility

Definition: The patient was referred to this facility by (a physician of) another health care facility not defined elsewhere in the code list.

Emergency room option discontinued 7/1/2010. To report use Condition Code P7.

8 = Court/Law enforcement

Definition: The patient was referred to this facility upon the direction of a court of law, or upon the request of a law enforcement agency representative for outpatient or referenced diagnostic services.

9 = Information not available

Definition: The means by which the patient was referred to this facility's outpatient department is not known.

D = Transfer from one distinct unit of the hospital to another distinct unit of the same hospital resulting in a separate claim to the payer.

Definition: The patient received outpatient services in this facility as a transfer from within this facility resulting in a separate claim to the payer.

E = Transfer from Ambulatory Surgery Center

Definition: The patient was referred to this facility for outpatient or referenced diagnostic services from an ambulatory surgery center.

F = Transfer from Hospice and is under a hospice plan of care or enrolled in a Hospice Program

Definition: The patient was referred to this facility for outpatient or referenced diagnostic services from a hospice.

Edit: The code must be present, valid, and in agreement with the Priority Type of Admission code: When Priority (Type) of Admission code = 1, 2,3 or 5, valid Point of Origin codes = 1 through 9 or D through F.

UB-04 FL 15

Descriptive Data Element Name: Priority of Admission (Previously Admit Type)

XSD Data Type: xs:string

Element Name: admit_type

Accepts Null values: No

Required in XSD: Yes

Minimum Constraint: 1

Maximum Constraint: 1

Definition: A code indicating the priority of the admission.

Comments: This code is a one-digit code between 1 through 5, or 9

1= Emergency

Definition: The patient requires immediate medical intervention as a result of severe, life threatening or potentially disabling conditions. Generally, the patient is admitted through the emergency room.

2= Urgent

Definition: The patient requires immediate attention for the care and treatment of a physical or mental disorder. Generally, the patient is admitted to the first available and suitable accommodation.

3= Elective

Definition: The patient condition permits adequate time to schedule the availability of a suitable accommodation. An elective admission can be delayed without substantial risk to the health of the individual.

4= Newborn

Definition: Generally, the child is born within the facility.

5= Trauma center

Definition: This code is for a visit to a trauma center/hospital as licensed or designated by the state or local government authorized to do so, or as verified by the American College of Surgeons and involving trauma activation.

9= Information is not available

Edit: The field must be:

- Present and valid
- Between 1 through 5, or 9

If Type of Admission = 4 (newborn):

- Point of origin codes must be 5 or 6
- Date of Birth must equal date of admission
- Diagnosis must be consistent with newborn

UB-04 FL 14

Descriptive Data Element Name: Patient Discharge Status

XSD Data Type: xs: string

Element Name: pat_disch_status

Accepts Null values: No

Required in XSD: Yes

Minimum Constraint: 2

Maximum Constraint: 2

Definition: A code indicating patient status at the time of discharge.

Comments: Codes for this two-digit field are:

- 01= Discharged to home or self-care (routine discharge)
- 02= Discharge/transferred to another short-term general hospital for inpatient care
- 03= Discharged/transferred to skilled nursing facility (SNF) with Medicare Certification in Anticipation of Skilled Care
- 04= Discharged/transferred to an intermediate care facility (ICF)
- 05= Discharged/Transferred to a designated cancer center or children's hospital. Effective 04-01-2008
- 06= Discharged/transferred to home under care of organized home health service organization
- 07= Left against medical advice or discontinued care
- 09= Admitted as an inpatient to this hospital
- 20= Expired
- 21= Discharge/transferred to court/law enforcement effective 10-01-09
- 43= Discharged/transferred to a federal health care facility.
- 50= Discharged to Hospice—home
- 51= Discharged to Hospice—medical facility
- 61= Discharged/transferred to a hospital-based Medicare approved swing bed.
- 62= Discharged/transferred to an inpatient rehabilitation facility (IRF) including distinct part units of a hospital.
- 63= Discharged/transferred to a long term care hospital (LTCH).
- 64= Discharged/transferred to a nursing facility certified under Medicaid but not certified under Medicare.
- 65= Discharged/transferred to a Psychiatric hospital or Psychiatric Distinct Part Unit of a Hospital.
- 66= Discharged/transferred to a Critical Access Hospital (CAH)
- 69= Discharged/transferred to a Designated Disaster Alternative Care Site
- 70= Discharged/transferred to another Type of Health Care Institution not defined elsewhere in this Code List. **Effective 10/01/07. For discharges prior to 10/01/07 use code 05.**
- 81= Discharged to home or Self Care with a Planned Acute Care Hospital Inpatient Readmission.
- 82= Discharged/transferred to a Short Term General Hospital for Inpatient Care with a Planned Acute Care Hospital Inpatient Readmission.
- 83= Discharged/transferred to a Skilled Nursing Facility (SNF) with Medicare Certification with a Planned Acute Care Hospital Inpatient Readmission.
- 84= Discharged/transferred to a Facility that provides Custodial or Supportive Care with a Planned Acute Care Hospital Inpatient Readmission.
- 85= Discharged/transferred to a Designated Cancer Center or Children's Hospital with a Planned Acute Care Hospital Inpatient Readmission
- 86= Discharged/transferred Home under Care of Organized Home Health Service Organization with a Planned Acute Care Hospital Inpatient Readmission.
- 87= Discharged/transferred to a Court /Law Enforcement with a Planned Acute Care Hospital Inpatient Readmission.
- 88= Discharged/transferred to a Federal health Care Facility with a Planned Acute Care Hospital Inpatient Readmission.
- 89= Discharged/transferred to a Hospital-based Medicare Approved Swing Bed with a Planned Acute Care Hospital Inpatient Readmission

- 90= Discharged/transferred to an Inpatient Rehabilitation Facility (IRF) including Rehabilitation Distinct part units of a Hospital with a Planned Acute Care Hospital Inpatient Readmission.
- 91= Discharged/transferred to a Short Term General Hospital for Inpatient Care with a Planned Acute Care Hospital Inpatient Readmission.
- 92= Discharged/transferred to a Nursing Facility Certified under Medicaid but not Certified under Medicare with a Planned Acute Care Hospital Inpatient Readmission.
- 93= Discharged/transferred to a Psychiatric Hospital or Psychiatric Distinct Part Unit of a Hospital with a Planned Acute Care Hospital Inpatient Readmission.
- 94= Discharged/transferred to a Critical Access Hospital (CAH) with a Planned Acute Care Hospital Inpatient Readmission.
- 95= Discharged/transferred to Another Type of Health Care Institution not Defined Elsewhere in the Code List with a Planned Acute Care Hospital Inpatient Readmission.

Edit: Discharge status code must be present and valid.

UB-04 FL 17

Descriptive Data Element Name: Condition Codes

XSD Data Type: xs: string

Element Name: condition_code

Accepts Null values: No

Required in XSD: No

Minimum Constraint: 2

Maximum Constraint: 2

Definition: A code(s) used to identify conditions or events relating to the bill that may affect processing.

Comments: Up to eleven (11) condition codes can be reported. Below are the codes we will be collecting however all codes will be accepted:

- 01 = Military Service Related
- 02 = Condition is Employment Related
- 17 = Patient is homeless
- 25 = Patient is not a US resident
- 26 = VA Eligible Patient Chooses to Receive Services in a Medicare Certified Facility
- 30 = Qualifying Clinical Trials
- 31 = Patient is a Student (Full Time Day)
- 32 = Patient is a Student (Cooperative Work Study Program)
- 33 = Patient is a Student (Full Time Night)
- 34 = Patient is a Student (Part Time)
- 40 = Same day transfer
- 44 = Inpatient admission changed to outpatient
- 45 = Ambiguous gender category
- 49 = Product Replacement within Product Lifecycle
- 50 = Product Replacement for Known Recall of a Product
- 57 = SNF readmission
- 81 = C-section/induction <39 weeks medically necessary
- 82 = C-section/induction <39 weeks elective
- 83 = C-section/induction 39 weeks or greater
- AI = Sterilization
- AK = Air Ambulance Required
- B3 = Pregnancy Indicator
- B4 = Admission unrelated to discharge on same day
- DR = Disaster related
- PI = Do not resuscitate. Use for public health reporting when required by the state.

P7 = Direct inpatient admission from Emergency room
 AA = Abortion performed due to rape
 AB = Abortion performed due to incest
 AC = Abortion performed due to serious fetal genetic defect, deformity or abnormality
 AD = Abortion performed due to a life endangering physical condition
 AE = Abortion performed due to physical health of mother that is not life threatening
 AF = Abortion performed due to emotional psychological health of the mother
 AG = Abortion performed due to social or economic reasons
 AH = Elective abortion

Edit: Must be a valid condition code.

UB-04 FL 18-28

Descriptive Data Element Name: External Cause of Injury Code (E-code) (1-6)

XSD Data Type: xs: string

Element Name: ecode

Accepts Null values: Yes

Required in XSD: No

Minimum Constraint: 4

Maximum Constraint: 6

Definition: The ICD-9-CM code for the external cause of an injury, poisoning, or adverse effect.

Comments: Required whenever there is any diagnosis (primary or secondary) of an injury, poisoning, or adverse effect (ICD-9-CM codes 800-999) and it is the initial treatment for that condition.

The priorities for recording an E-code are:

- Initial treatment of the injury or poisoning.
- Principal diagnosis of an injury or poisoning.
- Other diagnosis of an injury, poisoning or adverse effect directly related to the principal diagnosis.
- Other diagnosis with an external cause.
- When applicable, place of occurrence, activity, and external cause status codes are sequenced after the main external cause code(s). Regardless of the number of external cause codes assigned, there should be only one place of occurrence code, one activity code, and one external cause status code assigned to an encounter.
- Because the reporting format limits the number of external cause codes that can be reported, report the code for the cause/intent most related to the principal diagnosis. If the format permits capture of additional external cause codes, the cause/intent, including medical misadventures, of the additional events should be reported rather than the codes for place, activity, or external status.

Entries:

- Are without a decimal. If a decimal is included, the fifth digit is lost, which will result in an inaccurate E-code.
- Start with an uppercase E.

Edit:

- Ecode assignment should be based on coding guidelines and should be assigned accordingly.
- The same external cause code should not be reported in the external cause code fields and in the diagnosis string.

UB-04 FL 72a-c

Descriptive Data Element Name: **Attending Physician Identifier**

XSD Data Type: xs: string

Element Name: attending_phys_id

Accepts Null values: No

Required in XSD: Yes

Minimum Constraint: 6

Maximum Constraint: 10

Definition: The ten-digit National Provider Identifier Number (NPI) of the physician who certified and re-certified the medical necessity of the service rendered or who has primary responsibility for the patient's medical care and treatment.

Edit:

- Entry must be a valid NPI number.
- If the physician's NPI is unknown the NPI can be reported as OTH000

UB-04 FL 76

Descriptive Data Element Name: **Primary Payer Identifier – not required at this time**

XSD Data Type: xs: string

Element Name: prim_payer_id

Accepts Null values: No

Required in XSD: Yes

Minimum Constraint: 10

Maximum Constraint: 15

Definition: National Health Plan Identifier identifying the primary payer for this bill.

Comments: This field is to contain the National Health Plan Identifier of the primary payer organization.

Edit: The identifier must be that of a licensed health insurer or self-pay.

UB-04 FL 51a

Descriptive Data Element Name: **Primary Payer Name**

XSD Data Type: xs: string

Element Name: prim_payer_name

Accepts Null values: No

Required in XSD: Yes

Minimum Constraint: 2

Maximum Constraint: 50

Definition: Payer name identifying the primary payer for this bill.

Comments: This field is to contain the name of the primary payer, spelled out as completely as space allows. If a name has more than 50 characters, use abbreviations that can be used to uniquely identify the payer. If the patient paid for or was responsible for the outpatient encounter, primary payer should indicate self-pay.

Edit: The name must be present and that of a health insurer or self-pay.

UB-04 FL 50A

Descriptive Data Element Name: **Secondary Payer Identifier – not required at this time**

XSD Data Type: xs: string

Element Name: second_payer_id

Accepts Null values: Yes

Required in XSD: No

Minimum Constraint: 10

Maximum Constraint: 15

Definition: National Health Plan Identifier identifying the secondary payer for this bill.

Comments: This field is to contain the National Health Plan Identifier of the secondary payer organization.

Edit: The identifier must be that of a licensed health insurer or self-pay.

UB-04 FL 51B

Descriptive Data Element Name: **Secondary Payer Name**

XSD Data Type: xs: string

Element Name: second_payer_name

Accepts Null values: Yes

Required in XSD: No

Minimum Constraint: 2

Maximum Constraint: 50

Definition: Payer name identifying the secondary payer for this bill.

Comments: This field is to contain the name of the secondary payer, spelled out as completely as space allows. If a name has more than 50 characters, use abbreviations that can be used to uniquely identify the payer. If the patient paid for or was responsible for part of the outpatient encounter, secondary payer should indicate self-pay.

Edit: The name must be that of a licensed health insurer or self-pay

UB-04 FL 50B

Descriptive Data Element Name: Primary Payer Classification

XSD Data Type: xs: positiveInteger

Element Name: prim_payer_class

Accepts Null values: No

Required in XSD: Yes

Minimum Constraint: 1

Maximum Constraint: 1

Definition: This field indicates the payer group.

Comments: The payer group should be classified as:

1. **Commercial** - Includes HMO, PPO, POS, Indemnity, BCBS, Aetna, HealthChoice etc.
2. **Medicare** - Including HMO and insurance managed Medicare
3. **Medicaid** - Including Medicaid pending
4. **Veterans affairs / Military** - Includes Champus, ChampVA, Veteran's Hospital and Tricare.
5. **Workers Compensation**
6. **Uninsured/ Self -pay**
7. **Others** - Payers not in any of the above groups and including charity, Indian Health, auto-liability, DOC inmate, crime victim.

Edit: The code must be present and valid.

Currently not a UB-04 field.

Descriptive Data Element Name: Total Charges

XSD Data Type: xs: string

Element Name: total_charges

Accepts Null values: No

Required in XSD: Yes

Minimum Constraint: 2

Maximum Constraint: 7

Definition: The total charges associated with the patient's encounter.

Comments: This entry is:

- Rounded to nearest whole dollar
- A maximum of seven digits

Edit: This field must be present and valid. The field should equal the sum of subtotals of charges by revenue code fields.

UB-04 FL 47; Rev Code 0001

Descriptive Data Element Name: Type of Bill**XSD Data Type:** xs: string**Element Name:** bill_type**Accepts Null values:** No**Required in XSD:** Yes**Minimum Constraint:** 3**Maximum Constraint:** 4**Definition:** A code indicating the specific type of bill. The first digit is a leading zero and the fourth digit defines the frequency of the bill.**Comments:** The leading zero is not included on electronic claims. Even though all bill types are included in the table below, only inpatient bill types should be reported for inpatient data.

Type of Bill	Description	IP/OP
0000-010x	Reserved for Assignment by NUBC	
011x	Hospital Inpatient including Medicare Part A	IP
012x	Hospital Inpatient Medicare Part B only	OP/ 1, 3
013x	Hospital outpatient	OP
014x	Hospital – Laboratory Services Provided to Non-patients	OP/ 6
015x-017x	Reserved for Assignment by NUBC	
018x	Hospital – Swing Beds	IP
019x-020x	Reserved for Assignment by NUBC	
021x	Skilled Nursing – Inpatient including Medicare Part A	IP/ 2, 4
022x	Skilled Nursing – Inpatient including Medicare Part B	OP/ 1, 3
023x	Skilled Nursing – Outpatient	OP
024x-027x	Reserved for Assignment by NUBC	
028x	Skilled Nursing – Swing Beds	IP/ 3
029x-031x	Reserved for Assignment by NUBC	
032x	Home Health – Inpatient Medicare Part B only	OP/ 1
033x	Home Health – Outpatient Medicare Part A including DME	OP/ 1
034x	Home Health – Other	OP/ 1
035x-040x	Reserved for Assignment by NUBC	
041x	Religious Non-Medical Health Care Institutions	IP
042x	Reserved for Assignment by NUBC	
043x	Religious Non-Medical Health Care Institutions OP Services	OP
044x-064x	Reserved for Assignment by NUBC	
065x	Intermediate Care – Level I	IP/ 3
066x	Intermediate Care – Level II	IP/ 3
067x-070x	Reserved for Assignment by NUBC	
071x	Clinic – Rural Health	OP
072x	Clinic – Hospital Based/ Independent Renal Dialysis Center	OP
073x	Clinic – Freestanding	OP
074x	Clinic – Outpatient Rehabilitation Facility (ORF)	OP
075x	Clinic – Comprehensive OP Rehabilitation Facility (CORF)	OP
076x	Clinic – Community Mental Health Center	OP
077x	Clinic - Federally Qualified Health Center (FQHC)	OP
078x	Licensed Freestanding Emergency Medical Facility	OP
080x	Reserved for Assignment by NUBC	
081x	Special Facility – Hospice (non-hospital based)	OP/ 1
082x	Special Facility – Hospice (hospital based)	OP/ 1
083x	Special Facility – Ambulatory Surgery Center	OP
084x	Special Facility – Free Standing Birthing Center	IP

085x	Special Facility – Critical Access Hospital	OP
086x	Special Facility – Residential Facility	IP/ 3
087x-088x	Reserved for Assignment by NUBC	
089x	Special Facility – Other	IP or OP
090x-9999	Reserved for Assignment by NUBC	

Frequency – 4th Digit

- 0 = Non-payment / zero claim
- 1 = Admit through discharge claim
- 2 = Interim – 1st claim
- 3 = Interim – Continuing claim
- 4 = Interim – Last claim
- 5 = Late charges
- 7 = Replacement of prior claim
- 8 = Voiding/cancellation of prior claim
- 9= Final claim for Home Health PPS Episode

Edit: Type of Bill Code must be present and valid.

UB-04 FL 04

Descriptive Data Element Name: ICD Version Indicator

XSD Data Type: xs:integer

Element Name: icdv

Accepts Null values: No

Required in XSD: No

Minimum Constraint: 1

Maximum Constraint: 1

Definition: ICD Version indicator should be used on each record to indicate which version of the coding classification system is being used.

Comment: If the ICD Version Indicator is not on a record it will be assumed the version is ICD-9-CM

Edit: Entry must be a 0 or 9.

0 = ICD-10-CM/PCS is being used in this record for diagnosis codes.

9 = ICD-9-CM is being used in this record for diagnosis codes.

UB-04 FL 66

Data Elements **diag**

Total Attributes: 1

Total Elements: 1

Attribute Name: princ_diag

Data Element Name: oth_diag_code

Descriptive Data Element Name: Principal Diagnosis

XSD Data Type: xs:string

Attribute Name: princ_diag

Accepts Null values: No

Required in XSD: Yes

Minimum Constraint: 3

Maximum Constraint: 5

Definition: The ICD-9-CM code describing the condition or problem that is the reason for the encounter as shown in the provider records to be chiefly responsible for the outpatient services performed during this visit.

Comments: To code the principal diagnosis:

- Use an ICD-9-CM code without a decimal point.
- Enter all three, four, and five digits or to the highest level of specificity.
- Enter the "V" prefix as appropriate

Edit: A principal diagnosis must be:

- Present
- Valid
- Consistent with sex and age
- An E-code should not be entered as the principal diagnosis.

UB-04 FL 67

Descriptive Data Element Name: Other Diagnosis Codes (1 to 17)

XSD Data Type: xs:string

Element Name: oth_diag_code

Accepts Null values: Yes

Required in XSD: No

Minimum Constraint: 3

Maximum Constraint: 5

Definition: ICD-9-CM codes describing other diagnoses corresponding to additional conditions that co-exist at the time of the encounter or develop subsequently, and which have an effect on the treatment received or the length of stay.

Comments: Up to 17 secondary diagnoses may be recorded.

- Enter all three, four, and five digits to the highest level of specificity.
- Enter the E-code as appropriate if applicable.

Edit: A secondary diagnosis must be:

- Valid
- Consistent with sex and age

UB-04 FL 67a-o

Data Elements

procs

Total Attributes: 3

Total Elements: 1

Attribute Name: princ_cpt_proc, princ_cpt_proc_phys_id, princ_cpt_proc_date

Data Element Name: proc

Descriptive Data Element Name: Principal Procedure CPT Code and Modifiers

XSD Data Type: xs:string

Attribute Name: princ_cpt_proc

Accepts Null values: No

Required in XSD: Yes

Minimum Constraint: 5

Maximum Constraint: 13

Definition: The Principal Current Procedural Terminology (CPT) procedure code identifies the principal outpatient procedure performed during the outpatient encounter. The principal procedure is that procedure most related to the principal diagnosis.

A modifier provides the means by which the reporting physician can indicate that a service or procedure that has been performed has been altered by some specific circumstance but not changed in its definition or code.

Comments: Code entry should be in the first five positions in the field and include all digits. The remaining eight positions are for all qualifying modifiers, 2 characters in length with no space.

Edit: Principal Procedure CPT code field must be:

- Present unless one of the secondary diagnosis codes is V64.
- Valid
- Consistent with patient's sex and age

CPT Modifiers must be:

- Valid, if present
- Two digits in length
- Do not use a delimiter between modifiers.

UB-04 FL 44

Descriptive Data Element Name: Principal Procedure - Physician Identifier

XSD Data Type: xs:string

Attribute Name: princ_cpt_proc_phys_id

Accepts Null values: No

Required in XSD: Yes

Minimum Constraint: 6

Maximum Constraint: 10

Definition: The ten-digit National Provider Identifier (NPI) of the physician performing the principal procedure.

Edit: Field must contain a valid NPI.

UB-04 FL 77

Descriptive Data Element Name: Principal Procedure Date

XSD Data Type: xs:date

Attribute Name: princ_cpt_proc_date

Accepts Null values: No

Required in XSD: Yes

Minimum Constraint: 10

Maximum Constraint: 10

Definition: The date the principal procedure was performed.

Comments: Principal procedure date is in a ten digit format YYYY-MM-DD where:

- MM is the month in two digits ranging from 01 to 12
- DD is the day in two digits ranging from 01 to 31
- YYYY is the year of discharge (e.g. 2008)

Edit: Principal procedure date must be:

- Present
- Valid
- No earlier than date of encounter
- No later than discharge date
- No earlier than date of birth

UB-04 FL 6

Data Elements

procs/proc

Total Elements: 3

Data Element Name: oth_cpt_proc_code, oth_cpt_proc_phys_id, oth_cpt_proc_date

Descriptive Data Element Name: Other Procedure CPT Codes and Modifiers (1-5)

XSD Data Type: xs: string

Element Name: oth_cpt_proc_code

Accepts Null values: Yes

Required in XSD: No

Minimum Constraint: 5

Maximum Constraint: 13

Definition: The Current Procedural Terminology (CPT) procedure code(s) identifies all significant secondary procedure(s) performed during the outpatient encounter and any applicable modifiers.

A modifier provides the means by which the reporting physician can indicate that a service or procedure that has been performed has been altered by some specific circumstance but not changed in its definition or code.

Comments: Up to 5 secondary procedure CPT codes and modifiers may be recorded. Code entry should be in the first five positions in the field and include all digits. The remaining eight positions are for all qualifying modifiers, 2 characters in length with no space.

Edit: Other Procedure CPT Codes 1 – 5 field must be:

- Present only if a principal procedure CPT code is present
- Valid
- Consistent with patient's sex and age

CPT Modifiers must be:

- Valid, if present
- Two digits in length
- Do not use a delimiter between modifiers.

UB-04 FL 74 a-e

Descriptive Data Element Name: Other Procedure – Physician Identifiers (1-5)

XSD Data Type: xs: string

Element Name: oth_cpt_proc_phys_id

Accepts Null values: Yes

Required in XSD: No

Minimum Constraint: 6

Maximum Constraint: 10

Definition: The 10 digit National Provider Identifier (NPI) of the physician performing other or secondary procedure.

Edit: Field must contain a valid NPI.

UB-04 FL 78 and 79

Descriptive Data Element Name: Other Procedure Dates (1-5)

XSD Data Type: xs:date

Element Name: oth_cpt_proc_date

Accepts Null values: Yes

Required in XSD: No

Minimum Constraint: 10

Maximum Constraint: 10

Definition: The date(s) that all significant other procedure(s) were performed other than the principal procedure.

Comments: Other procedure dates has a ten digit format YYYY-MM-DD where:

- MM is the month in two digits ranging from 01 to 12
- DD is the day in two digits ranging from 01 to 31
- YYYY is the year of discharge (e.g. 2008)

Edit: Other Procedure date must be:

- Valid
- No earlier than date of encounter
- No later than discharge date
- No earlier than date of birth

UB-04 FL 6

Data Elements **apcs/apc**

Descriptive Data Element Name: Facility Assigned Ambulatory Patient Classification APC (1-3)

XSD Data Type: xs:string

Element Name: apc

Accepts Null values: Yes

Required in XSD: No

Minimum Constraint: 3

Maximum Constraint: 5

Definition: The Ambulatory Patient Classification(s) assigned to the outpatient record by the facility.

Comments: The APC field has to be between three to five digits in length or can be preceded with zeroes.

Edit: The APC field must be:

- Valid
- Consistent with age and sex

Currently not a UB-04 field.

Total Elements: 3

Descriptive Data Element Name: rev_code, units_service, tot_charges_rev_cat

Descriptive Data Element Name: Revenue Code 0001-9999

XSD Data Type: xs: string

Element Name: rev_code

Accepts Null values: No

Required in XSD: Yes

Minimum Constraint: 3

Maximum Constraint: 4

Definition: The revenue code is a four-digit code and identifies a specific accommodation, ancillary service or billing calculation. The fourth digit denotes a subcategory number. The subcategory number provides a more detailed list generally ranging from 0 – 9. When reporting the revenue code the fourth position must include one of the numeric choices available in that category.

Comments: Report the highest level of specificity when reporting revenue codes which are listed in Table 3.

Edit: Revenue code must be:

- Present
- Valid

UB-04 FL 42

Descriptive Data Element Name: Units of Service by revenue code 0001-9999

XSD Data Type: xs: string

Element Name: units_service

Accepts Null values: No

Required in XSD: No

Minimum Constraint: 1

Maximum Constraint: 7

Definition: The number of units of service rendered for each line item within each revenue code.

Comments: All valid revenue codes are listed in Table 3

Edit: The units of service must be present:

- If the revenue code requires a unit, and the total charges for the revenue code are greater than zero (0).

UB-04 FL 46

Descriptive Data Element Name: Charges by revenue code 0001-9999

XSD Data Type: xs: string

Element Name: tot_charges_rev_cat

Accepts Null values: No

Required in XSD: Yes

Minimum Constraint: 1

Maximum Constraint: 7

Definition: The total charge for each revenue code.

All valid revenue codes are defined in Table 3-Revenue Codes as well as the appropriate Units of Service

Comments: The total allows for a six-digit dollar amount (no cents or decimal point). The charge should be rounded to the nearest whole dollar.

Edit: The sum of all revenue code charges should equal the total charges for surgery encounter.

UB-04 FL 42

Data Elements value_codes/value_code

Total Elements: 2

Descriptive Data Element Name: value_code_cd, value_code_amt

Descriptive Data Element Name: Value Code

XSD Data Type: xs:string

Element Name: value_code_cd

Accepts Null values: No

Required in XSD: No

Minimum Constraint: 2

Maximum Constraint: 2

Definition: A code structure to relate amounts or values to identify data elements necessary to process this claim as qualified by the payer organization.

Comments: Up to twelve (12) value codes and amounts can be reported. Below are the codes we will be collecting however all codes will be accepted:

04 = Professional Component Charges which are combined billed

05 = Professional Component Included in Charges and also Billed Separate to Carrier

15 = Workers compensation

16 = PHS or Other Federal Agency

45 = Accident Hour

50 = Physical Therapy Visits

51 = Occupational Therapy Visits

52 = Speech Therapy Visits

53 = Cardiac Rehab Visits

54 = Newborn birth weight in grams

A0 = Special Zip Code Reporting

A8 = Patient Weight

A9 = Patient Height

D4 = Clinical Trial Number Assigned by NLM/NIH

G8 = Facility where Inpatient Hospice Service is Delivered

Edit: Must be a valid value code.

UB-04 FL 39-41

Descriptive Data Element Name: Value Code Amount

XSD Data Type: xs:string

Element Name: value_code_amt

Accepts Null values: No

Required in XSD: No

Minimum Constraint: 1

Maximum Constraint: 9

Definition: A code structure to relate amounts or values to identify data elements necessary to process this claim as qualified by the payer organization.

Comments: Up to 12 value codes and amounts can be reported

Edit: Must be whole numbers.

UB-04 FL 39-41

Data Elements

hci_data/Trailer

Total Elements: 1

Element Name: total_records

Descriptive Data Element Name: Total number of records in file

XSD Data Type: xs:positiveInteger

Element Name: total_records

Accepts Null values: No

Required in XSD: Yes

Minimum Constraint: 1

Maximum Constraint: none

Definition: Total number of records in the file submitted.

Edit: Must reflect the actual total number of records.

Currently not a UB-04 field

Table 3 - Revenue Codes and Units of Service

This section defines valid revenue codes representing services provided to a patient, and the unit of measure associated with each revenue service. Only these codes are valid. The source of the codes and definitions is the published manual of the National Uniform Billing Committee.

Revenue Code: The revenue code is a four-digit code and identifies a specific accommodation, ancillary service or billing calculation.

Subcategory: The fourth digit denotes a subcategory number. The subcategory number provides a more detailed list generally ranging from 0 – 9. When reporting the revenue code the fourth position must include one of the numeric choices available in that category.

Units of Service: The units used to measure the patient services in each revenue category, such as number of accommodation days, miles, pints, or treatments.

DESCRIPTION OF REVENUE CATEGORIES

Code	Unit	Description	Subcategory
0001		Total Charges – The total for all revenue codes associated with a patient stay.	
001x		Reserved	
002x		Health Insurance - Prospective Payment System (HIPPS)- This revenue code is used to denote that a HIPPS rate code is being reported in FL44	2-4
0025-0029		Reserved	
003x - 009x		Reserved	
010x	Days	All-inclusive rate—a flat fee charge incurred on either a daily basis or total stay basis for services rendered. Charge may cover room and board plus ancillary services or room and board only.	0-1
011x	Days	Room and board - Private - One bed. Routine service charges for accommodations in a private room.	0-9
012x	Days	Room and board - Semi-private - two beds. Routine service charges for accommodations in a semi-private room.	0-9
013x	Days	Room and Board - Three and Four Beds. Routine service charges for rooms with three or four beds.	0-9
014x	Days	Room and Board - Deluxe Private - Deluxe accommodations substantially in excess of private room services.	0-9
015x	Days	Room and board - Ward. Routine service charges for accommodations with five or more beds.	0-9
016x	Days	Room and board, other - Any routine service charges for accommodations that cannot be included in the more specific revenue center codes.	0,4,7,9
017x	Days	Nursery - Accommodation charges for nursing care to newborns and premature infants in nurseries.	0-4, 9
018x	Days	Leave of absence - charges for holding a room while the patient is temporarily away from the provider.	0, 2, 3, 5, 9
019x	Days	Subacute care - Accommodations charges for subacute care to inpatients or skilled nursing facilities.	0-4, 9
020x	Days	Intensive care - routine service charges for medical or surgical care provided to patients who require a more intensive level of care than is rendered in the general medical or surgical unit.	0-4, 6-9

Code	Unit	Description	Subcategory
021x	Days	Coronary care - routine service charges for medical care provided to patients with coronary illness who require a more intensive level of care than is rendered in the general medical care unit.	0-4, 9
022x	None	Special charges - charges incurred during an inpatient stay or on a daily basis for certain services.	0-4, 9
023x	Hours	Incremental nursing charge - Extraordinary charges for nursing services assessed in addition to the normal nursing charge associated with the typical room and board unit.	0-5, 9
024x	None	All-inclusive ancillary - A flat-rate charge that is applied on a daily basis or on a total stay basis for ancillary services only.	0-3, 9
025x	None	Pharmacy (also see 063x, and extension of 025x) - Charges for medications produced, manufactured, packaged, controlled, assayed, dispensed and distributed under the direction of licensed pharmacist.	0-9
026x	None	IV therapy - equipment charge or administration of intravenous solution by specially trained personnel to individuals requiring such treatment.	0-4, 9
027x	None	Medical/surgical supplies and devices (See also 062x, and extension of 027x) - Charges for supply items required for patient care.	0-9
028x	None	Oncology - charges for the treatment of tumors and related diseases.	0, 9
029x	None	Durable medical equipment (other than renal) - charges for medical equipment that can withstand repeated use.	0-4, 9
030x	Tests	Laboratory - Charges for the performance of diagnostic and routine clinical laboratory tests.	0-7, 9
031x	Tests	Laboratory pathology - charges for diagnostic and routine laboratory tests on tissues and cultures.	0-2, 4, 9
032x	Tests	Radiology - Diagnostic - Charges for diagnostic radiology services including interpretation of radiographs and fluorographs.	0-4, 9
033x	Tests	Radiology - Therapeutic - Charges for therapeutic radiology services and chemotherapy administration to care and treat patients. Includes therapy by injection or ingestion of radioactive substances. Excludes charges for chemotherapy drugs.	0-3, 5, 9
034x	Tests	Nuclear medicine - Charges for procedures, tests and radiopharmaceuticals performed by a department handling radioactive materials as required for diagnosis and treatment of patients.	0-4, 9
035x	Tests	CT scan - charges for computed tomographic scans of the head and other parts of the body.	0-2, 9
036x	None	Operating room services - charges for services provided to patients by specifically trained nursing personnel who provide assistance to physicians in the performance of surgical and related procedures during and immediately following surgery.	0-2, 7, 9
037x	None	Anesthesia - charges for anesthesia services.	0-2,4,9
038x	Pints	Blood and blood components.	0-7, 9

Code	Unit	Description	Subcategory
039x	Pints	Administration, Processing and Storage for Blood and Blood components - Charges for administration, processing and storage of whole blood, red blood cells, platelets and other blood components.	0-2, 9
040x	Tests	Other imaging services	0-4, 9
041x	Treatment	Respiratory services - charges for respiratory services including administration of oxygen and certain potent drugs through inhalation or positive pressure and other forms of rehabilitative therapy.	0, 2-3, 9
042x	HCPCS	Physical therapy - charges for therapeutic exercises, massage and utilization of effective date properties of light, heat, cold, water, electricity, and assisting devices for diagnosis and rehabilitation of patients whom have neuromuscular, orthopedic and other disabilities.	0-4, 9
043x	HCPCS	Occupational therapy - charges for therapeutic interventions to improve, sustain, or restore an individual's level of function in performance, of activities of daily living and work, including, therapeutic activities, therapeutic exercises, sensorimotor processing, psychosocial skills training, cognitive retraining, fabrication and application of orthotic devices, and training in the use of orthotic and prosthetic devices, adaptation of environments, and applications of physical agent modalities.	0-4, 9
044x	HCPCS	Speech Therapy - charges for services related to impaired functional communications skills.	0-4, 9
045x	Visit	Emergency room - charges for emergency treatment to those ill and injured persons who require immediate and unscheduled medical or surgical care.	0-2, 6, 9
046x	Tests	Pulmonary function - charges for tests that measure inhaled and exhaled gases and analysis of blood and for tests that evaluate the patient's ability to exchange oxygen and other exhaled gases.	0,9
047x	Tests	Audiology - charges for the detection and management of communication handicaps centering in whole or in part on the hearing function.	0-2, 9
048x	Tests	Cardiology - charges for cardiac procedures.	0-3, 9
049x	HCPCS	Ambulatory surgical care - charges for ambulatory surgery that is not covered by other categories.	0,9
050x	Tests	Outpatient services - Charges for services rendered to an outpatient who is admitted as an inpatient before midnight of the day following the date of service. Medicare no longer requires this revenue code.	0,9
051x	Visit	Clinic - charges for providing diagnostic, preventative, curative, rehabilitative, and education services to ambulatory patients.	0-7, 9
052x	Visit	Free-standing clinic	0-9
053x	Visit	Osteopathic services - charges for a structural evaluation of the cranium, entire cervical, dorsal and lumbar spine by a doctor of osteopathy.	0-1, 9
054x	Mile/Item/Unit	Ambulance - Charges for ambulance service necessary for the transport to the ill and injured who require medical attention at a healthcare facility.	0-9
055x	Visit/Hour	Home Health - Skilled Nursing - Charges for nursing services provided under the direct supervision of a home health licensed nurse.	0-2, 9

Code	Unit	Description	Subcategory
056x	Visit/Hour	Home Health - Medical social services - Charges for services such as counseling patients, interviewing patients, and interpreting problems of social situation rendered to patients on any basis.	0-2, 9
057x	Visit/Hour	Home Health - Aide - Home Health charges for personnel (aides) that are primarily responsible for the personal care of the patient.	0-2, 9
058x	Visit/Hour	Home Health - Other Visits - Home Health agency charges for the visits other than physical therapy, occupational therapy or speech therapy, requiring specific identification.	0-3, 9
059x	Unit	Home Health - Units of Service - Home Health charges for services billed according to the units of service provided.	0
060x	Ft/Lbs/Mos	Home Health - Oxygen - Home Health agency charges for oxygen equipment, supplies or contents, excluding purchased equipment.	0-4, 9
061x	Tests	Magnetic Resonance Technology (MRT) - Charges for Magnetic Resonance Imaging and Magnetic Resonance Angiography.	0-2, 4-6, 8-9
062x	HCPCS	Medicare/Surgical supplies - Extension of 027x - Charges for supply items required for patient care. The category is an extension of code 27x for reporting additional breakdown where needed. Subcategory code 1 is for providers that cannot bill supplies used for radiology procedures under radiology. Subcategory code 2 is for providers that cannot bill supplies used for other diagnostic procedures.	1-4
063x	HCPCS	Pharmacy - Extension of 025x - Charges for medication produced, manufactured, packaged, controlled, assayed, dispensed and distributed under the direction of a licensed pharmacist. The category is an extension of 025x for reporting additional breakdown where needed.	1-7
064x	Hours	Home IV Therapy Services - Charge for intravenous therapy services performed in the patient's residence. For Home IV providers enter the HCPCS code for all equipment, and all types of covered therapy.	0-9
065x	Hours/Days/HCPCS	Hospices service - charges for hospice care services for a terminally ill patient if he elects these services in lieu of other medical services for the terminal condition.	0-2, 5-9
066x	Hours/Days	Respite Care - Charge for non-hospice respite care.	0-3,9
067x	Days	Outpatient Special Residence Charges - Residence arrangements for patients requiring continuous outpatient care.	0-2,9
068x	Activation	Trauma Response - Charges representing the activation of the trauma team.	1-4, 9
069x	None	Pre-hospice/Palliative Care Services Category	0-6, 9
070x	None	Cast room - charges for services related to the application, maintenance and removal of casts.	0
071x	None	Recovery room	0
072x	Days/Each	Labor room and delivery - charges for labor and delivery room services provided by specially trained nursing personnel to patients including prenatal care during labor, assistance during delivery, postnatal care in the recovery room, and minor gynecological procedures if they are performed in the delivery suite.	0-4, 9

Code	Unit	Description	Subcategory
073x	Tests	EKG/ECG (Electrocardiogram) - charges for operation of specialized equipment to record variations in actions of the heart muscle for diagnosis of heart ailments.	0-2, 9
074x	Tests	EEG (Electroencephalogram) - charges for operation of specialized equipment to measure impulse frequencies and differences in electrical potential in various areas of the brain to obtain data for use in diagnosing brain disorders.	0
075x	Tests	Gastrointestinal services - Charges for gastrointestinal procedures not performed in the operating room.	0
076x	None	Specialty Room - Treatment/observation room - Charges for the use of a specialty room such as a treatment or observation room.	0-2, 9
077x	None	Preventive Care Services - Revenue Code used to capture preventive care services established by payers.	0-1
078x	None	Telemedicine - Facility charges related to the use of telemedicine services.	0
079x	None	Extra-Corporeal Shock Wave Therapy (formerly Lithotripsy) - Charges related to Extra-Corporeal Shock Wave Therapy.	0
080x	Sessions	Inpatient Renal Dialysis - Charges for the use of equipment designed to remove waste when the body's own kidneys have failed.	0-4, 9
081x	None	Acquisition of Body Components - the acquisition and storage costs of body tissue, bone marrow, organs and other body components not otherwise identified used for transplantation.	0-4,9
082x	Sessions	Hemodialysis - Outpatient or Home - A waste removal process performed in an outpatient or home setting, necessary when the body's own kidneys have failed.	0-5,9
083x	Sessions	Peritoneal Dialysis - Outpatient or Home - Charges for a waste removal process performed in an outpatient or home setting, necessary when the body's own kidneys have failed.	0-5, 9
084x	Days	Continuous Ambulatory Peritoneal Dialysis (CAPD) - Outpatient or Home - Charges for continuous dialysis process performed in an outpatient or home setting which uses the patient peritoneal membrane as a dialyzer.	0-5, 9
085x	Days	Continuous Cycling Peritoneal Dialysis (CCPD) - Outpatient or Home - Charges for continuous dialysis process performed in an outpatient or home setting which uses a machine to make automatic exchanges at night.	0-5, 9
086x	None	Magnetoencephalography	0, 1
087x		Reserved	
088x	Sessions	Miscellaneous Dialysis - Charges for dialysis services not identified elsewhere.	0-2, 9
089x		Reserved	
090x	Visit	Behavioral Health Treatment/Services (see also 091x, and extension of 090x) - Charges for prevention, intervention and treatment services in the areas of mental health, substance abuse, developmental disabilities, and sexuality. Behavioral Health Care services are individualized, holistic, and culturally competent and may include on-going care and support and non-traditional services.	0-7

Code	Unit	Description	Subcategory
091x	Visit	Behavioral Health Treatment/Services - Extension of 090x - See Revenue code 090x	1-9
092x	Tests	Other diagnostic services - Charges for various diagnostic services specific to common screenings for disease, illness or medical condition.	0-5, 9
093x	Hours	Medical Rehabilitation Day Program - Medical rehabilitation services as contracted with a payer and /or certified by the state. Services may include physical therapy, occupational therapy, and speech therapy	1-2
094x	Visit	Other therapeutic services (see also 095x, and extension of 094x) - charges for other therapeutic services not otherwise categorized.	0-7, 9
095x	Visit	Other Therapeutic services - (Extension of 094x) - See Revenue Code 094x	1-3
096x	None	Professional fees (see also 097x and 098x) - Charges for medical professionals that the institutional health care provider along with the third party payer require the professional fee component to be billed on the UB The professional fee component is separately identified by this revenue code. Generally used by Critical Access Hospitals that bill both the technical and professional component on the UB.	0-4, 9
097x	None	Professional fees (Extension of 096x) - See Revenue Code 096x.	1-9
098x	None	Professional fees (Extension of 096x and 097x) - Charges for medical professionals that the institutional health care provider along with the third-party payer require the professional fee component to be billed on the UB. The professional fee component is separately identified by this revenue code. Generally used by critical access hospitals.	1-9
099x	None	Patient convenience items - charges for items that are generally considered by the third party payers to be strictly convenience items and therefore are not covered by many health plans.	0-9
100x	Days	Behavioral Health Accommodations - Charges for routine accommodations at specified behavioral health facilities.	0-5
101x - 209x		Reserved	
210x	Sessions	Alternative Therapy Services - Charges for therapies not elsewhere categorized under other therapeutic service revenue codes (042x, 043x, 044x, 091x, 094x, 095x) or services such as anesthesia or clinic (0374, 0511)	0-6, 9
211x - 309x		Reserved	
310x	Hour/Day	Adult Care - Charges for person, medical, psycho-social, and/or therapeutic services in a special community setting for adults needing supervision and/or assistance with Activities of Daily Living (ADL).	1-5, 9
311x - 999x		Reserved	

Outpatient Code editor

Outpatient code editing (OCE) will be applied to the records submitted for the patient's encounter. The edit process checks for potential problems in a record identifying highly improbable clinical situations, which in most cases, prove to be in error. The OCE will flag records when any of the conditions are detected.

Invalid diagnosis code - The OCE checks each diagnosis entered in the record against a table of valid ICD-9-CM codes. If a code is not found in the table the record is flagged as in error. The OCE also edits for a complete diagnosis code. If a diagnosis code is on a claim without a required fourth or fifth digit, it is considered invalid.

Age conflict - The OCE detects inconsistencies between a patient's age and any diagnosis on the patient's claim. Examples of such conflicts are a 5-year-old patient with benign prostatic hypertrophy. In such cases the diagnosis or the age is presumed to be incorrect.

Diagnosis and sex conflict - The OCE detects inconsistencies between a patient's sex and any diagnosis on the patient's record. Examples of such conflicts are a male patient with cervical cancer. In such cases either the patient's diagnosis or sex is presumed to be incorrect.

E-Code as reason for visit - E-codes describes the circumstances that caused an injury, not the nature of the injury, and therefore, are not accepted by OCE as a principal diagnosis.

Invalid procedure code – The OCE checks each HCPCS procedure code against a table of valid HCPCS codes for the time period shown on the claim. If the reported code is not in this table, the code is considered invalid. Valid HCPCS codes are listed in the Current Procedural Terminology, 4th Edition, published by the American Medical Association. Some national codes from the Health Care Financing Administration's Common Procedure Coding System (HCPCS) Level II codes are also included for services not described by CPT codes.

Procedure and sex conflict – The OCE detects inconsistencies between a patient's sex and any HCPCS procedure code. An example of a sex conflict is a male patient reported to have had a dilation and curettage (D&C). Since the procedure conflicts with the sex of the patient, either the patient's sex or the procedure is presumed incorrect.

Invalid date - The OCE checks the dates for validity. This edit occurs if there is not date or if the date is not within the normal calendar range.

Date out of OCE range – The OCE checks the date and applies this edit if the dates of service are prior to July 1, 1987. The OCE was not established until this date.

Invalid or unknown age - OCE allows entry of patient age from 0 through 124 years. Any other entry is considered an error.

Invalid or unknown sex – The sex code reported must be either "M" for male or "F" for female. If anything else is entered on the claim, it is invalid.

Procedure and age conflict – The OCE detects inconsistencies between a patient's age and any HCPCS procedure code.

Multiple bilateral procedures without modifier 50 – The OCE identifies HCPC codes that can be performed bilaterally when the code is entered more than once for a single date of service if modifier 50 is not on either of the codes. Modifier 50 is defined as "bilateral procedure." For example, if the physician performed HCPCS 25066 (Biopsy, soft tissue of forearm and /or wrist; deep) on both the right and left wrist, 25066 should not be on two lines. The correct way is to show the code for the biopsy on one line with 2506650.

Inappropriate specification of bilateral procedure – The OCE identifies HCPCS codes that can be performed bilaterally if the code is entered more than one time for the same date of service when all or some codes include modifier 50. This edit will also identify when a procedure with "bilateral" in its HCCPCS definition is entered on more than one time.

Notes:

Health Care Information Staff and Contact Information (405) 271-6225

*Lou Ann Sanders, RHIT LPN Health Information Specialist.....louanns@health.ok.gov
Heather Hunn RHIA.....Health Information Specialist.....heathernh@health.ok.gov
Jeffrey CarlisleIT.....jeffreyc@health.ok.gov
Derek Pate, DrPHDirectorderekp@health.ok.gov

*Primary Contact

