

# Oklahoma Department of Labor

Oklahoma Welding Act

59 O.S. § 1624, *et seq.*

Welding Rules

OAC 380:20

Current as of January 14, 2019



**Leslie Osborn**  
**Commissioner of Labor**

This publication is issued by the Oklahoma Department of Labor as authorized by Labor Commissioner Leslie Osborn. Copies have not been printed but are available through the agency website. The publisher of this booklet does not warrant the correctness of the information contained in this booklet. The "official" version of the Oklahoma Administrative Code must be obtained from the Office of Administrative Rules, Oklahoma Secretary of State, 405-521-4911, [www.sos.ok.gov](http://www.sos.ok.gov).

# Oklahoma Welding Act and Administrative Rules

## Table of Contents

<b>Oklahoma Welding Act</b> .....	<b>1</b>
59 O.S. § 1624 Short Title .....	1
59 O.S. § 1625 Description and Legislative Intent.....	1
59 O.S. § 1626 Definitions .....	1
59 O.S. § 1627 Welding Inspectors – Power and Duties .....	2
59 O.S. § 1628 Applicants for Certification – Qualifications .....	3
59 O.S. § 1629 Certification of Applicants .....	3
59 O.S. § 1630 Standards of Skills, Practice and Conduct of Welding Inspectors .....	3
59 O.S. § 1631 Unauthorized Practice – Suspension, Refused Renewal or Revocation of Certification .....	5
59 O.S. § 1632 Reinstatement .....	5
59 O.S. § 1633 Recertification .....	5
59 O.S. § 1634 Applicability of Codes – Qualifications of Welders – Penalties .....	5
59 O.S. § 1634.1 Applicable Codes for Weldments.....	6
59 O.S. § 1635 Commissioner of Labor – Additional Powers and Duties	7
59 O.S. § 1636 Fees and Certificates.....	7
59 O.S. § 1637 Disposition of Revenues .....	7
59 O.S. § 1638 Exemptions .....	7
59 O.S. § 1639 Owner May Require Welder to Qualify with Appropriate Code – Exempt Equipment .....	8
59 O.S. § 1640 Violations – Misdemeanor – Penalties.....	8
59 O.S. § 1641 Construction of Act .....	8
<b>Administrative Rules</b> .....	<b>9</b>
380:20-1-1. Purpose.....	9
380:20-1-2. General certification requirements .....	9
380:20-1-3. Welding inspectors .....	10
380:20-1-4. Limitations affecting welding inspector certifications ..	13

380:20-1-5.	Penalties .....	13
380:20-1-6.	Application procedure - weld-test facility .....	13
380:20-1-7.	Weld-test facility certification .....	13
380:20-1-8.	Limitations affecting weld-test facility certifications....	14
380:20-1-9.	Weld-test facility application affidavit (non-owner-user) .....	15
380:20-1-10.	Welding inspector certification; procedure .....	15
380:20-1-11.	Limitations affecting welding inspector certification....	15
380:20-1-12.	Weld-test facility application affidavit (owner-user) ...	15
380:20-1-13.	Welding inspector application affidavit .....	15
380:20-1-14.	Welding procedure specifications for butt weld .....	16
380:20-1-15.	Welding procedure specifications for structural steel welding .....	17
Appendix A.	Procedure Okla. D.P. - 1 Vertical Fixed Position (2-G) Only .....	18
Appendix B.	Procedure Okla. D.P. - 1 Horizontal Fixed Position (5-G) .....	19
Appendix C.	Procedure Okla. D.P.- 1 Fixed Inclined Position (6-G).	20
Appendix D.	Procedure Okla. D.P. - 2 .....	21
Appendix E.	Weld-Test Facility Application Affidavit (Non Owner-User) .....	22
Appendix F.	Weld-Test Facility Application Affidavit (Owner-User) .	23
Appendix G.	Welding Inspector Application Affidavit.....	24

## **Oklahoma Welding Act**

### **59 O.S. § 1624      Short Title**

This act shall be known and may be cited as the "Oklahoma Welding Act."

### **59 O.S. § 1625      Description and Legislative Intent**

- A. This act describes the welding inspector's basic technical functions, the requirements by which welding personnel may become qualified, and the principles of conduct and practice by which certification may be maintained. The certification procedure shall apply to personnel who inspect weldments.
- B. This act is intended to supplement any requirements of an employer, code, standard or specification and shall not be construed as a preemption of the employer's responsibility for the work or for the performance of such work.

### **59 O.S. § 1626      Definitions**

As used in this act:

- 1. "Certificate" means the document issued to an applicant upon successful examination;
- 2. "Certification" means the testimony of qualifications;
- 3. "Code" means United States of America National Standard Institute Code;
- 4. "Committee" means the Oklahoma State Labor Department, Boiler Inspection Department, Chief Boiler Inspector;
- 5. "Qualification" means the successful completion of all parts of the requirements set out by the Oklahoma Department of Labor;
- 6. "Welding inspector" means a person who has met the requirements of this act;
- 7. "Weld-testing facility" means a qualified and approved testing facility approved by the Oklahoma Department of Labor;
- 8. "Weldment" means a welded assembly in which the bulk of the component parts are prepared and joined by any combination of the cutting and welding processes covered by Section 1628 of this title;
- 9. "Work" means that portion of the product or weldment that specifically involves or affects the use of welding;
- 10. "Welder" means a person who has met the requirements of this act; and
- 11. "Structural steel or steel deck welding" has the same meaning as defined in American Welding Society D1.1 and D1.3.

## **59 O.S. § 1627      Welding Inspectors – Power and Duties**

A welding inspector shall have the following powers and duties:

1. Verify that the work which he inspects conforms to the requirements of the applicable codes, standards and job specifications;
2. Verify that the base materials and consumable welding materials conform to the specification requirements and that the specified welding filler metals are used on each base metal or combination of base metals;
3. Verify that the welding equipment to be used for the work is that which is specified in the welding procedure and has the capability to produce the specified welds;
4. Verify that the welding procedures are as specified, qualified and available to the welders for reference;
5. Verify that the welders have been properly qualified in accordance with the applicable codes and standards, and that their qualification authorizes them to use the welding procedures specified for the work. If there is evidence that the welder's work does not conform to the requirements of the applicable code, standard or specification, the welding inspector may require requalification of a welder, if that person's qualification is not current by the requirements of the applicable codes, standards or specifications;
6. When qualifying welders, the welding inspector shall observe the qualification tests;
7. Verify that only specified and properly qualified welding procedures are used for the work;
8. Verify that the joint preparation and fit-up meets the requirements of the welding procedure and drawings;
9. Verify that the specified filler metals are used and that the filler metals are maintained in proper condition for use as specified;
10. Observe the technique and performance of each welder;
11. Examine the work for conformance to the requirements of the applicable codes, standards, specifications and drawings;
12. Identify the work he inspects with specified marking methods or appropriate records;
13. Perform the necessary visual inspections;
14. Verify that the required visual and other nondestructive examinations have been performed by qualified personnel in the specified manner. He shall review the resulting information to assure that the results are complete. The welding inspector may perform nondestructive examinations that are specified, providing he is qualified in accordance with the specified requirements; and
15. Prepare clear and concise reports and keep necessary records of the welding procedure, the welding procedure qualifications, the welding qualifications, the control of welding materials and the results of

inspections and tests. It shall be the duty of the welding inspector to see that all test results are forwarded to the Department of Labor for issuance of welder certification cards.

**59 O.S. § 1628      Applicants for Certification – Qualifications**

Each applicant for certification as a welding inspector shall have the following qualifications:

1. Maintenance experience involving the detection and measurement of weld inadequacies or discontinuities in accordance with specified procedures;
2. Repair experience involving the repair or replacement of welds that were determined inadequate or defective by reference to a code, standard, specification or drawing;
3. Familiarity with and understanding of the fundamentals of the following processes:
  - a. shielded metal arc welding,
  - b. stud arc welding,
  - c. submerged arc welding,
  - d. flux cored arc welding,
  - e. gas metal arc welding,
  - f. gas tungsten arc welding,
  - g. electroslag welding,
  - h. oxyfuel gas welding,
  - i. brazing,
  - j. thermal cutting, and
  - k. mechanical cutting. Cutting processes refer only to those processes that are applied to the fabrication and repair of weldments;
4. Capability in writing clear and concise reports and maintaining records; and
5. Competency in the use of tools, gauges and instruments pertaining to weld inspection.

**59 O.S. § 1629      Certification of Applicants**

The Oklahoma State Labor Department shall issue to each applicant successfully meeting the qualifications requirements provided in Section 1628 of this title a certificate stating that the applicant has met the certification requirements. The certificate shall be valid for one (1) year unless revoked pursuant to Section 1631 of this title.

**59 O.S. § 1630      Standards of Skills, Practice and Conduct of Welding Inspectors**

- A. In order to safeguard the public health and well-being and to maintain integrity and high standards of skills, practice and conduct in the occupation of welding inspection, the certified welding inspector shall

be cognizant of the principles provided in this section and the scope to which they apply with the understanding that any unauthorized practice is subject to the Committee's review and may result in suspension or revocation of certification.

- B. The welding inspector shall act with complete integrity in professional matters and be forthright and candid to the representatives on matters pertaining to this act.
- C. The welding inspector shall preserve the health and well-being of the public by performing the duties required of welding inspectors in a conscientious and impartial manner to the full extent of his moral and civic responsibilities and qualifications. Accordingly, the welding inspector shall:
  - 1. Undertake and perform assignments only when qualified by training, experience and capability; and
  - 2. Be completely objective, thorough and factual in any written report, statement or testimony of the work and include all relevant or pertinent information in such communiques or testimonials.
- D. With regard to public statements, the welding inspector shall:
  - 1. Issue no statements, criticisms or arguments on weld inspection matters connected with public policy which are inspired or paid for by one or more interested parties without first identifying the party and speaker, and disclosing any possible pecuniary interest; and
  - 2. Publicly express no opinion on a weld inspection subject unless it is founded upon an adequate knowledge of the facts in issue, upon a background of technical competence pertinent to the subject, and upon honest conviction of the accuracy and propriety of the statement.
- E. With regard to conflicts of interest, the welding inspector shall:
  - 1. Conscientiously avoid conflict of interest with his client and shall disclose any business association, interests or circumstances that might be so considered;
  - 2. Not accept compensation, financial or otherwise, from more than one party for services on the same project, or for services pertaining to the same project, unless the circumstances are fully disclosed and agreed to by all interested parties or their authorized agents;
  - 3. Not solicit or accept gratuities, directly or indirectly, from one or more parties dealing with the client or employer in connection with the welding inspector's work; and
  - 4. Neither inspect, review nor approve any work on behalf of one or more parties, while serving in the capacity of an elected, retained or employed public official.

- F. With regard to solicitation of employment, the welding inspector shall:
  - 1. Neither pay, solicit nor offer, directly or indirectly, any bribe or commission for professional employment with the exception of the usual commission or fees required; and
  - 2. Neither falsify, exaggerate nor indulge in the misrepresentation of personal academic and professional qualifications, past assignments, accomplishments and responsibilities, or those of his associates.

**59 O.S. § 1631      Unauthorized Practice – Suspension, Refused Renewal or Revocation of Certification**

The Oklahoma Commissioner of Labor shall have the power to suspend, refuse renewal of or revoke the welding inspector's certification, and the power to place on probation or to reprimand the holder, if he is found guilty of an unauthorized practice. The Commissioner of Labor may apply to any court of competent jurisdiction for an enforcement of its administrative decisions and rulings.

**59 O.S. § 1632      Reinstatement**

Reinstatement of a revoked certification shall be allowed with no penalty or prejudice to the individual, provided the reason for such revocation has been rectified to the Commissioner of Labor's satisfaction.

**59 O.S. § 1633      Recertification**

- A. The welding inspector shall be recertified upon payment of the current fee and successful reexamination of complete facilities every year. However, renewal applicants who attest to continual or uninterrupted activity in the practice of welding inspection and who comply with the provisions of Sections 141.1 through 141.20 of Title 40 of the Oklahoma Statutes and 380:25-13-3 of the Oklahoma Administrative Code shall be recertified upon payment of the current certification fee without reexamination.
- B. Application for renewal of a certification that has expired shall be considered a new application.
- C. The welding inspector shall be responsible for maintaining a current address with the State Department of Labor, Boiler Inspector Department, for mailing of renewal notices.

**59 O.S. § 1634      Applicability of Codes – Qualifications of Welders – Penalties**

- A. The following American Society of Mechanical Engineers Codes, based upon the latest edition, shall be the piping codes for this state:
  - 1. The power piping code, ASME B31.1;
  - 2. The fuel gas piping code, ASME B31.2;



3. The gas transmission and distribution piping system code, ASME B31.8;
  4. The process piping code, ASME B31.3; and
  5. The liquid transportation systems for hydrocarbons, liquid petroleum gas, anhydrous ammonia and alcohols code, ASME 31.4.
- B. The American Welding Society D1.1 and D1.3 shall be the structural steel welding codes for this state.
  - C. The provisions of this act shall apply only to weldments required by the above codes.
  - D. All welders prior to performing weldments within this state on any piping enumerated in subsection A of this section or structural steel welding enumerated in subsection B of this section shall be tested, qualified and certified by the Commissioner of Labor pursuant to this act.
  - E. It shall be mandatory upon the owner, or a contractor to whom a contract is awarded and upon any welders wherein welders are to perform weldments on any piping enumerated in subsection A, upon any subcontractor under the owner or a contractor, to ensure that all welders performing weldments within this state shall be certified by the Commissioner of Labor before any weldments are fabricated.
  - F. Penalties:
    1. Any welder who violates or omits to comply with any of the provisions of this section, and any officer, agent or representative of any owner or any contractor or subcontractor who violates or omits to comply with any of the provisions of this section shall be subjected to the penalties provided in this title.
    2. The Commissioner of Labor is empowered to issue cease and desist orders against violations of this act until such time as compliance of the law is met. If an owner, welder, contractor and/or subcontractor fails to obey the orders issued by the Commissioner of Labor, the Attorney General shall review the case and initiate necessary proceedings for contempt of the Commissioner's order and/or ask for an injunction in the district court as deemed appropriate to the facts of the case.
    3. No person, firm or corporation or agent thereof shall in any manner interfere with the performance of the duties of any inspector or representative of the Commissioner of Labor for the implementation of this act.

**59 O.S. § 1634.1 Applicable Codes for Weldments**

Notwithstanding any other provision of law, weldments subject to the provisions of Section 1624 et seq. of this title and performed on and after the effective date of this act shall meet the standards of the following codes:

American Society of Mechanical Engineers (ASME) Section IX and American Petroleum Institute (API) 1104, 1107 and American Welding Society D1.1 and D1.3.

**59 O.S. § 1635 Commissioner of Labor – Additional Powers and Duties**

The Commissioner of Labor shall have the following duties in addition to any other duties prescribed by law:

1. Examine, certify and renew the certification of qualified applicants and keep a record of all such proceedings;
2. Promulgate rules concerning the quality of welds and qualification of welders;
3. Designate and approve persons qualified to administer welding tests; and
4. Designate and approve shops, testing facilities or other establishments qualified for testing coupons and weldments.

**59 O.S. § 1636 Fees and Certificates**

- A. The certification fee for each welder shall be Twenty-five Dollars (\$25.00). An additional fee of Ten Dollars (\$10.00) shall be paid if the welder's certification has expired prior to renewal. The certification fee for each welding inspector shall be One Hundred Dollars (\$100.00). The certification fee for each testing facility shall be Two Hundred Fifty Dollars (\$250.00).
- B. Certificates for welders and testing facilities and welding inspectors shall be issued for a period of one (1) year, and shall be renewed by January 1 of each year for testing facility applicants and welding inspectors, and on the last day of the welder applicant's birth month; provided, however, that no welder applicant shall be required to renew his license more than once during any twelve-month period. Failure to renew the certificates within one (1) year of expiration shall require recertification.

**59 O.S. § 1637 Disposition of Revenues**

All revenues collected under the provisions of this act shall be paid by the Department of Labor to the State Treasurer and by him placed to the credit of the General Revenue Fund of the state, to be used for governmental functions and to be paid out only pursuant to direct appropriation by the Legislature of the State of Oklahoma.

**59 O.S. § 1638 Exemptions**

- A. Upon the effective date of this act, owner-user inspectors following weldment procedures which conform to the applicable code for qualifying welders and testing weldments by nondestructive or

- destructive methods shall be exempt from this act. Any inspector who has been certified by the American Welding Society shall be exempt.
- B. Any weld-test facility, which has been approved and certified under this title by the Oklahoma Department of Labor on or before January 1, 1979, to test and qualify welder operators and which has as its primary function the testing and qualifying of welder operators, shall be approved to continue as authorized and may operate using inspectors who have documentation of a minimum of seven (7) years of the last ten (10) years of experience in the inspection field.
  - C. The Commissioner of Labor shall, upon proper application and the payment of fees within ninety (90) days after the effective date of this act, and annually thereafter upon payment of the fees provided herein shall issue certification without examination to those persons who test and qualify welder operators, upon producing proof satisfactory to the Commissioner, that they meet the requirements of this section, and who have otherwise complied with the provisions of this act.
  - D. For one (1) year from the effective date of this act, structural steel welders with five (5) or more years of experience, as verified by the Department of Labor, shall not be required to pass a welding test, but must otherwise comply with the provisions of this act and the rules promulgated by the Department of Labor to implement the Oklahoma Welding Act.

**59 O.S. § 1639      Owner May Require Welder to Qualify with Appropriate Code – Exempt Equipment**

If a welder holds a state certificate, the owner may require the welder to qualify in accordance with the appropriate code whenever deemed necessary, and reject the welder if qualifying test is failed. Any equipment fabricated in compliance with existing codes is exempt from this act.

**59 O.S. § 1640      Violations – Misdemeanor – Penalties**

Any person who violates the provisions of this act shall be guilty of a misdemeanor and upon conviction thereof shall be punished by payment of a fine of Five Hundred Dollars (\$500.00).

**59 O.S. § 1641      Construction of Act**

Nothing in this act shall be construed to affect or modify any unexpired welder certification issued prior to the adoption hereof. Holders of unexpired welder certifications issued by the Commissioner of Labor shall be entitled to renew said certificates as herein provided.

## **Administrative Rules**

### **380:20-1-1. Purpose**

The purpose of the rules in Chapter 20 is to provide guidance for the implementation of standards for the licensing of welders, certification of weld test facilities, and certification of welding inspectors as mandated by Title 59 of Oklahoma Statutes, Section 1624, et seq.

### **380:20-1-2. General certification requirements**

The Rules contained in Chapter 20 are applicable to the specific construction Codes adopted in the Oklahoma Welding Law, found in Title 59 O.S. Section 1624, et seq. The Oklahoma Boiler and Pressure Vessel Safety Act, Title 40, O.S., Sections 141.1 et seq., contains the Statutes for new construction, field assembly, alteration, and repair of boilers and pressure vessels. For new construction and repair of welded down stream piping operated or designed to operate in excess of 15 P.S.I. pressure, welder performance test and certification of test reports must be made by an Oklahoma Weld-Test Facility certified by the Department of Labor in accordance with the following procedures.

- (1) The welding inspector shall:
  - (A) Forward properly certified and signed test reports to the Department of Labor.
  - (B) Make sure that the permanent address of the welder is included in the test reports. These test reports shall contain the following information as a minimum: complete name and mailing address of the welder; welding position(s) in which the weld test(s) was/were performed; welding process or processes used; date(s) of test(s); social security number; birth date; hair color; eye color; height; weight; complete name and mailing address of the weld test facility; and the state assigned identification number of the weld test facility.
- (2) The welder shall:
  - (A) Apply for a welder's certification card on forms provided by the Department of Labor.
  - (B) Perform certification weld coupon(s) to a qualified ASME, API, or AWS Weld Procedure Specification;
  - (C) Include a twenty-five dollar (\$25.00) check, money order, or certified check payable to the Oklahoma Department of Labor;
  - (D) Renew their certification cards by the last day of the welders birth month each year. Failure to renew certification cards within one year of expiration shall require retesting and re-certification.

- (E) Welders certification cards once issued become the sole property of the individual whose name appears on the card and must be carried on the person of the welder when performing weldment(s) in this state;
  - (F) Be responsible for maintaining a Welders Continuity Log to verify that welder certification has been maintained in every qualified process by the making of weldments at least every six (6) months as may be required by the applicable ASME, API or AWS Code(s). Such documentation shall be made available to inspectors or employer upon request. The welder certification card issued to any welder shall become invalid when the Welder Continuity Log is not maintained as required by these Rules. An invalid certification card shall be considered valid again only when the welder satisfactorily retests. Such retesting must be performed prior to the expiration date of the certification card. Such periods of inactivity shall not impact the expiration date of the welder's certification card.
- (3) The Department of Labor shall:
- (A) Document and file test results and welder applications,
  - (B) Mail welder's certification card to the welder's address as listed on the welder's application.

**380:20-1-3. Welding inspectors**

- (a) The intent of Title 59 O.S. Section 1627 is that the welding inspector be physically present during the welders fusing of the test materials and that he witness the test fused materials from fit up through fusion, preparation of coupons and ultimate destructive test or to the on-site nondestructive examination personnel. Therefore the welding inspectors test report must contain the following statement: "I certify that I personally witnessed all phases of the welding performance test of the above named welder and that the above data reflects a true report of the test results."
- (b) The following definitions shall apply to this Chapter:
  - (1) "ASME" means the American Society of Mechanical Engineers, Three Park Avenue, New York, 10016-5990;
  - (2) "API" means the American Petroleum Institute, 1220 L Street, Northwest, Washington, D.C. 20005-4070;
  - (3) "ASTM" means American Society of Testing and Materials, 100 Bar Harbor Drive, P.O. Box C700, West Conshohocken, PA 19428-2959;
  - (4) "AWS" means the American Welding Society, 550 N.W. LeJeune Road, Miami, Florida 33126;

- (5) "Certificate," or "Certification Card" means the document issued to an applicant upon successful examination;
  - (6) "Destructive" means to bend or pull the weld test coupon to see if it cracks or breaks;
  - (7) "NDE" means a nondestructive examination;
  - (8) "Welding Inspector" means any person certified as a welding inspector in accordance with Section 1628 of this Act, or any person in possession of one of more of the following certifications issued by the American Welding Society:
    - (A) Senior Certified Welding Inspector ("SCWI");
    - (B) Certified Welding Inspector ("CWI");
    - (C) Certified Associate Welding Inspector ("CAWI").
  - (9) "Welding Procedure Specification" ("WPS") means a written document providing direction to the welder for making production welds in accordance with Code requirements by identifying all essential, supplemental essential, and non-essential variables.
  - (10) "Structure" means any commercial or industrial building intended for human occupancy where any part of the building is fabricated, constructed, altered, repaired or enlarged using weldable material found in AWS D1.1 or D1.3 in the welding process.
  - (11) "Continuity log" means a written record that verifies a welder has maintained their certification in every qualified process by producing sound welds at least every 6 months as may be required by the applicable ASME, API or AWS code(s).
- (c) The welding inspector shall forward all welder test results properly certified showing under which qualified procedure the welder tested (as permitted by this Act) to the Department of Labor. Upon receipt of the completed application affidavit, the test results and the twenty-five dollar (\$25.00) application affidavit fee, pursuant to 380:20-1-2(2)(C), the certification card will be mailed to the welder.
  - (d) All welding inspector certifications will specify with which weld-test facility the inspector is associated.
  - (e) Title 59 O.S. Section 1638 refers to an owner-user inspector and a certified AWS inspector as being exempt from the Act under certain conditions.
    - (1) For the purpose of clarifying Title 59 O.S. Section 1638, an owner-user is defined as a firm, company or organization which owns the piping which is being constructed, modified or repaired by full time company employees of the firm. This excludes high pressure steam (in excess of 15 P.S.I.) power piping (boiler external piping) falling within the scope of Section I of the Boiler and Pressure Vessel Code of the American Society of Mechanical

Engineers and the Oklahoma Boiler and Pressure Vessel Law, Title 40 O.S. Section 141.1, et seq.

- (2) For the purpose of clarifying Title 59 O.S. Section 1638, an owner-user inspector is defined as an inspector working as a paid company employee inspecting welds and qualifying welders to weld only those welds on owner piping facilities. The Department of Labor will recognize owner-user inspectors for purposes of certifying their welders qualifications only. (Any inspection required by virtue of the Oklahoma Boiler Code such as boiler repair and high-pressure steam lines shall be performed in accordance with the provisions of the Boiler and Pressure Vessel Law, Title 40 O.S. Section 141.1 et seq.)
- (f) A certified welding inspector may witness welder performance qualification in the field, provided the field testing facility is equipped with proper the test equipment (destructive or NDE devices).
- (g) Except for owner-user situations and organizations in possession of a valid Certificate of Authorization issued by the ASME or the National Board of Boiler and Pressure Vessel Inspectors, no certified welding inspector or certified testing facility shall be affiliated with any parent or subsidiary company which builds, constructs, erects or repairs piping systems designed in accordance with the provisions of any of the Codes identified in this Act, 40 O.S. 1624 et seq.
- (h) For the purpose of welder certification, no welding inspector or testing facility certified by the Department of Labor shall certify any welders in their own employ or any welders in the employment of any parent organization unless done by an employee of an owner-user organization as per 380:20-1-3(e)(2), or an organization in possession of a valid Certificate of Authorization from the ASME or the National Board of Boiler and Pressure Vessel Inspectors.
- (i) For the purpose of certifying welders by the Department of Labor, all certified welding inspectors and certified test facilities shall qualify, observe and test welders under one of the procedures and specifications referred to as:
  - (1) D.P.-1 or;
  - (2) D.P.-2 or;
  - (3) Any welding procedure certified in accordance with Section IX of the ASME Boiler and Pressure Vessel Code sanctioned by the welder's employer; or
  - (4) Any welding procedures certified in accordance with API Standard 1104 sanctioned by the welder's employer; or
  - (5) Any appropriate AWS standard welding procedure.
- (j) The welder must successfully qualify in all respects to the selected procedure and all new test results forwarded to the Department of Labor shall so specify the welding process or processes used, and the

position or positions in which welded. Test results shall remain valid for one year from the date the test weldment was performed.

**380:20-1-4. Limitations affecting welding inspector certifications**

A welding inspector certification is non-transferable. Upon a certified welding inspector's termination from a weld-test facility, his certification shall be deemed cancelled.

**380:20-1-5. Penalties**

- (a) The Oklahoma Welding Act ( Title 59 O.S. Section 1631), provides the Oklahoma Commissioner of Labor shall have the power to suspend, refuse renewal of or revoke the welding inspector's certification, and the power to place on probation or to reprimand the holder, if he is found guilty of an unauthorized practice. The Commissioner of Labor may apply to any court of competent jurisdiction for an enforcement of its administrative decisions and rulings.
- (b) The Oklahoma Welding Act (Title 59 O.S. Section 1640), provides any person who violates its provisions shall be guilty of a misdemeanor and upon conviction thereof shall be punished by payment of a fine of Five Hundred Dollars (\$500.00).

**380:20-1-6. Application procedure - weld-test facility**

To facilitate uniform welding certification, the State Department of Labor will issue to each applicant successfully meeting the qualifications requirements a certificate stating that the applicant has met the certification requirements. The certifications shall be valid for one (1) year unless revoked pursuant to the Oklahoma Welding Act, Title 59 O.S. Sections 1624-1641. The certification fee for each weld-test facility shall be two hundred-fifty dollars (\$250.00). The certification shall be issued for a period of one (1) year, and shall be renewed by January 1<sup>st</sup> of each year. Failure to renew the certificate within thirty (30) days of expiration shall require certification.

**380:20-1-7. Weld-test facility certification**

- (a) Each weld test facility shall as a minimum:
  - (1) Have in their employ, a weld inspector in possession of a current American Welding Society Inspector Certification and be certified by the Commissioner of Labor; or
  - (2) Have in their employ, a weld inspector with a minimum of seven (7) years of the last ten (10) years of experience in the weld inspection field and be certified by the Commissioner of Labor; or
  - (3) Be certified as an owner-user welding inspector.
- (b) Each Weld-Test Facility shall have adequate welding equipment, material and staff personnel to perform any and all tests set forth by



the requirements of the Oklahoma Welding Act and the Oklahoma Boiler and Pressure Vessel Safety Act, Title 40 of the Oklahoma Statutes 40 Section 141.1, et seq.

- (c) Any organization in possession of a valid Certificate of Authorization from the American Society of Mechanical Engineers or the National Board of Boiler and Pressure Vessel Inspectors may be certified as a weld test facility. Each such organization must have in effect a valid quality control system addressing welder qualification in accordance with the requirements of Section IX of the ASME Boiler and Pressure Vessel Code. Welder's Performance Qualifications may be used to certify only those welders being full time employees of the Certificate of Authorization holder and welder testing for the purpose of certification shall not be made available to the general public.

**380:20-1-8. Limitations affecting weld-test facility certifications**

- (a) Upon termination of employment of a certified welding inspector at the weld-test facility, the weld-test facility certification shall be deemed temporarily suspended until such time as the Department of Labor certifies another welding inspector for the facility.
- (b) All weld-test facility certifications are non-transferable.
- (c) Any weld-test facility certified by the Commissioner of Labor wherein welders are instructed and/or undergoing welding training are prohibited from certifying the qualifications of their own student welders connected with said school unless there exists on file with the Department of Labor, a written Quality Control System detailing those controls necessary to maintain separation of the classroom and inspection/certification functions of the facility. The quality control system shall be signature approved by the Chief Boiler Inspector or Deputy Boiler Inspector and shall as a minimum include all of the following elements:
  - (1) There shall be a forward statement signed by a senior company official stating that the inspector has the freedom to fail any weld certification test coupon that does not satisfy the requirements of this Act and the applicable referencing Code;
  - (2) The inspector must be certified in accordance with the provisions of this Act;
  - (3) The inspector may conduct formal welder instruction but shall not be permitted to conduct certification examinations on welders which he has been responsible for training;
  - (4) Any changes that are to be made to the written Quality Control System shall be approved by the Chief Boiler Inspector prior to implementation; and

- (5) Facilities shall be open to random surveillance by the Chief or Deputy Boiler Inspector without prior notification. There shall be no cost associated with such surveillance.
- (d) Any weld-test facilities except owner-user weld-test facilities certified by the Commissioner of Labor, must make their facilities available to the general public as a testing lab for qualifying welders.
- (e) Each applicant for a weld-test facility shall make application in affidavit form to the Oklahoma State Department of Labor and file with the Department a thorough and factual written report in reference to procedures, equipment, integrity, standards of skills, practices and conduct in the occupation of inspection and testing and shall be cognizant of the principles and scope of rules which may apply.
- (f) Upon receiving the request, the application affidavit and the two hundred-fifty dollars (\$250.00) certification fee, the Department of Labor will inspect the facilities, and upon approval the weld-test facility will be issued a certification card.

**380:20-1-9. Weld-test facility application affidavit (non-owner-user)**

Application for weld-test facility (public non-owner-user) shall be on affidavit forms provided by the Department of Labor. See Appendix E.

**380:20-1-10. Welding inspector certification; procedure**

- (a) Each welding inspector shall have as minimum qualifications:
  - (1) A current American Welding Society Welding Inspectors Certification; or
  - (2) A minimum of seven (7) years of the last ten (10) years of documented experience in the weld inspection field as required by Title 59 O.S. 59 Section 1628 of this Act; or
  - (3) Have current employment documentation as an owner-user inspector.
- (b) Each welding inspector applicant is to make application to the Department of Labor using the appropriate application affidavit forms as specified by the Department of Labor. See Appendix G.

**380:20-1-11. Limitations affecting welding inspector certification**

Upon the termination of employment of a certified welding inspector at a weld-test facility, the welding inspector certification shall be deemed canceled. A welding inspector certification is non-transferable.

**380:20-1-12. Weld-test facility application affidavit (owner-user)**

Application for weld-test facility (owner-user) shall be on affidavit forms as specified by the Department of Labor. See Appendix F.

**380:20-1-13. Welding inspector application affidavit**

- (a) The welding inspector application shall include the following:

- (1) Name of Welding Inspector - Applicant
- (2) Enclose a copy of American Welding Society Certification; documentation of seven (7) years of the last ten (10) years experience as a welding inspector; or proof of current employment if an owner-user inspector.
- (3) Name of company employing applicant to inspect weldments.
- (b) The welding inspector application shall be on affidavit forms as specified by the Department of Labor. See Appendix G.

**380:20-1-14. Welding procedure specifications for butt weld**

- (a) **Specifications.**
  - (1) Number Okla. D.P.-1 (without backing ring)
  - (2) Number Okla. D.P.-2 (with backing ring)
- (b) **Process.**
  - (1) S.M.A.W.- Shielded Metal Arc Welding
  - (2) G.M.A.W. - Gas Metal-Arc Welding
  - (3) G.T.A.W. - Gas Tungsten-Arc Welding
  - (4) O.F.G.W. - Oxyfuel Gas Welding
- (c) **Base Material.** The base material shall conform to the specifications of the following:
  - (1) ASME Boiler & Pressure Vessel Code, as applicable
  - (2) A.P.I. STD 1104 as applicable
  - (3) AWS Part A, as applicable
- (d) **Forgings.** Filler metal; The filler metal shall conform to the applicable code requirements of specifications under which the welder is being qualified, and restricted to the particular welding process being utilized. Applicable codes: ASME Section IX, current Edition and addenda, ASME B31.1, current Edition and addenda, API 1104, current Edition and addenda, and AWS D1.1, current Edition and addenda.
- (e) **Position.** The welding shall be done in test position 2G and 5G or 5G or 6G, as described in Section IX of the ASME Boiler and Pressure Vessel Code or positions described in AWS D1.1 or D1.3.
- (f) **Preparation of base material.** The edges or surfaces of the parts to be joined by welding shall be prepared by being machined, ground or gas cut to form groove design joints, as shown on the attached appendices and shall be cleaned of all oil and grease and excessive amounts of scale or rust. Fillet design joints shall not be used for welder certification.
- (g) **Nature of electric current.** The current shall be DC, the base metal to be on the negative side of the line.
- (h) **Welding technique.** The welding technique, electrode size and mean voltages and currents for each electrode shall be substantially as shown on attached appendices.

- (i) **Appearance of welding layers.** The welding current and manner of depositing the weld material shall have the appearance shown on the attached appendices. There shall be practically no undercutting on the side walls or the welding groove or the adjoining material.
- (j) **Cleaning.** All slag or flux remaining on any bead of welding shall be removed before laying down the next successive bead.
- (k) **Defects.** Any cracks or blow holes that appear on the surface shall be removed by chipping, grinding or gas gouging before depositing the next successive bead of welding.
- (l) **Heat treatment.** The heat treating or stress relieving of completed welds, when required, shall be performed in accordance with the requirements of the specific code under which the work is conducted.

**380:20-1-15. Welding procedure specifications for structural steel welding**

The welding procedure specifications for structural steel welding is that which is found in AWS D1.1 and/or D1.3.

# Appendix A. Procedure Okla. D.P. - 1 Vertical Fixed Position (2-G) Only

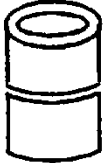

**Test Position 2-G**  
Axis of pipe or plate fixed in the vertical position.

Diameter of electrode	Amps	Minimum Volts
3/32" to 1/8"	70-120	20
3/32" to 5/32"	100-160	20

**Note:** No. of beads shown may be increased or decreased 25%

---

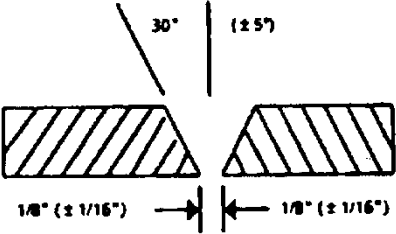

30° (±5°)  
1/8" (±1/16")

Beveling and spacing for pipe or plate 1/4" to 1/2" wall thickness

**.250" wall thickness**

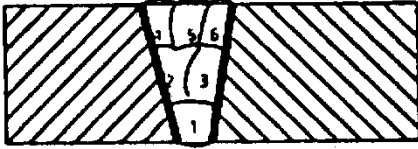

No. 1,2,3 beads 3/32" to 1/8" electrode  
No. 4,5,6 beads 3/32" to 5/32" electrode

---

**.375" wall thickness**

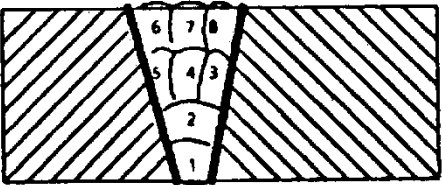

No. 1-2 beads - 3/32" to 1/8" electrode.  
No. 3,4,5,6,7,8 beads 3/32" to 5/32" electrode

**.500" wall thickness**

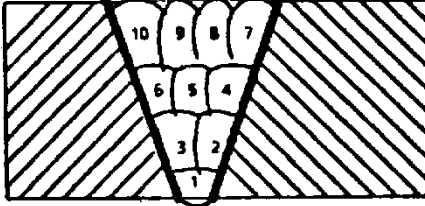

No. 1 to 4 beads 3/32" to 1/8" electrode.  
No. 5 to 10 beads 3/32" to 5/32" electrode.

---

**.625" wall thickness**

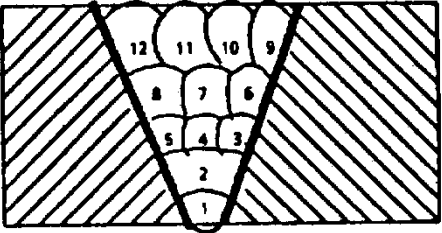

No. 1-2 beads 3/32" to 1/8" electrode.  
No. 3-12 beads 3/32" to 5/32" electrode.

**.750" wall thickness**

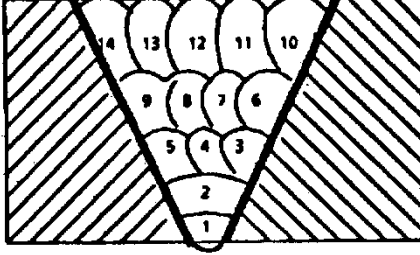

No. 1-2 beads 3/32" to 1/8" electrode.  
No. 2-12 beads 3/32" to 5/32" electrode.

**Exceptions -** (1) When root pass is deposited with G.T.A.W. process 3/32" filler material is acceptable. (2) When remaining weld deposits are made using low hydrogen electrodes, 3/32" diameter electrodes are permissible.

## Appendix B. Procedure Okla. D.P. - 1 Horizontal Fixed Position (5-G)

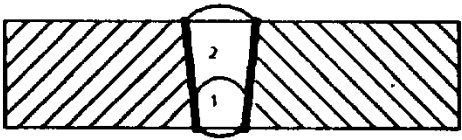
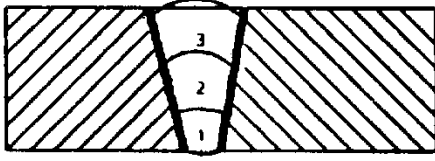
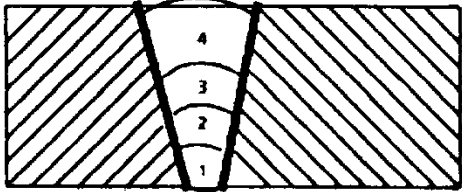
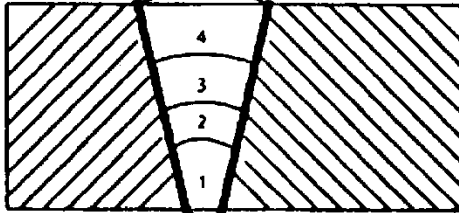
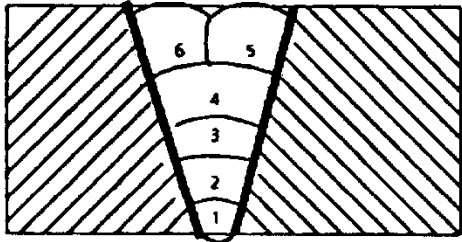
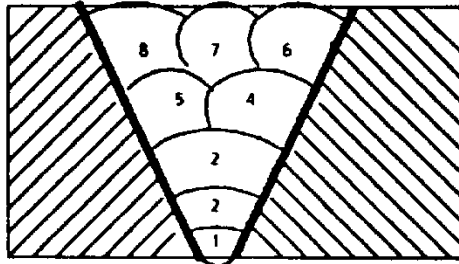
<p>2" min. to 12" max. or actual job size.</p>  <p>Test Position 5-G Axis of pipe in the horizontal fixed position.</p> <p>Note: Beveling and spacing to be the same as shown for position 2-G</p>	<table border="1" data-bbox="782 415 1224 583"> <thead> <tr> <th>Diameter of electrode</th> <th>Amps</th> <th>Minimum Volts</th> </tr> </thead> <tbody> <tr> <td>3/32" to 1/8"</td> <td>70-120</td> <td>20</td> </tr> <tr> <td>3/32" to 5/32"</td> <td>100-160</td> <td>20</td> </tr> </tbody> </table> <p>Note: No. of beads shown may be increased or decreased 25% if "T" = .500</p>	Diameter of electrode	Amps	Minimum Volts	3/32" to 1/8"	70-120	20	3/32" to 5/32"	100-160	20
Diameter of electrode	Amps	Minimum Volts								
3/32" to 1/8"	70-120	20								
3/32" to 5/32"	100-160	20								
<p>.125" wall thickness</p>  <p>No. 1-2 string beads 3/32" to 1/8" electrode</p>	<p>.250" wall thickness</p>  <p>No. 1 string bead 3/32" to 1/8" electrode No. 283 weaving beads 5/32" electrode</p>									
<p>.375" wall thickness</p>  <p>No. 1 string bead 3/32" to 1/8" electrode No. 2 to 4 weav. beads 1/8" to 5/32" electrode</p>	<p>.500" wall thickness</p>  <p>No. 1 string bead 3/32" to 1/8" electrode No. 2 to 4 weav. beads 1/8" to 5/32" electrode</p>									
<p>.625" wall thickness</p>  <p>No. 1 string bead 3/32" to 1/8" electrode No. 2 to 6 weav. bead 1/8" to 5/32" electrode</p>	<p>.750" wall thickness</p>  <p>No. 1 string bead 3/32" to 1/8" electrode No. 2 to 8 weav. beads 1/8" to 5/32" electrode.</p>									

**Appendix C. Procedure Okla. D.P.- 1 Fixed Inclined Position (6-G)**

**PROCEDURE**

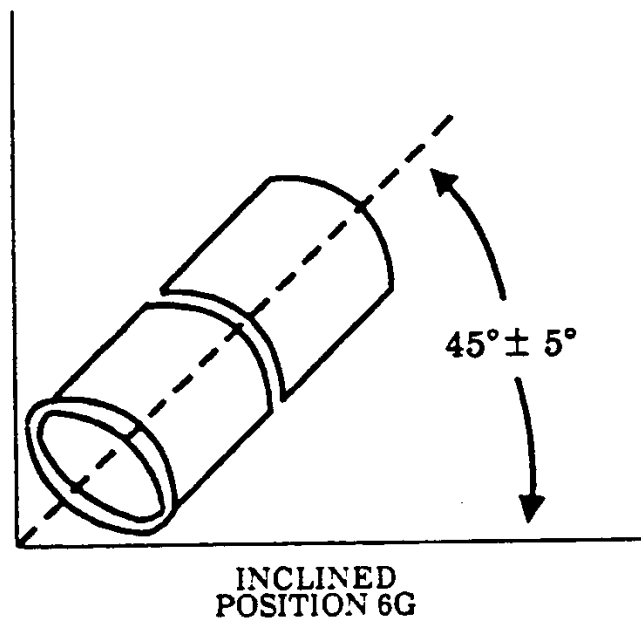

**PIPE WELDING**

**TO BE QUALIFIED TO WELD PIPE IN ALL POSITIONS A WELDER SHALL PASS TESTS IN THE 2G AND 5G OR 6G POSITION.**

Appendix D. Procedure Okla. D.P. - 2

Procedure Okla. D.P. - 2 (with welding rings) shall conform to the specifications of Procedure Okla. D.P. - 1 (without welding rings) rod size, amps, minimum arc in volts, and various positions shall be the same as Procedure Okla. D.P. - 1. Welding rings shall conform to the ASME Boiler Construction Code, and A.N.S.I Power Piping Code B31.1 and shall be the groove type welding rings with knock-off spacer pin or the ridge type as manufactured by the tube turn, as shown in the following sketches under Procedure Okla. D.P. - 2. Ferrous rings, nonferrous, nonmetallic or consumable inserts may be used accordingly in compliance with applicable codes.

