

EVALUATION OF AQUIFER PERFORMANCE AND WATER SUPPLY CAPABILITIES
OF THE ELK CITY AQUIFER IN WASHITA, BECKHAM, CUSTER,
AND ROGER MILLS COUNTIES, OKLAHOMA

FINAL REPORT

Submitted
To

THE OKLAHOMA WATER RESOURCES BOARD

By
Douglas C. Kent
Principal Investigator

And

Tim Lyons
Fred E. Witz

Department of Geology
Oklahoma State University

May, 1982

Contents of this report are for administrative purposes and may not be published or reproduced in any form with prior consent of the cooperators involved.



PERSONNEL INVOLVED
OKLAHOMA STATE UNIVERSITY

Douglas C. Kent	Professor of Geology and Principal Investigator
Fred E. Witz	Computer Specialist
Timothy D. Lyons	Graduate Research Assistant
James W. Patterson, Jr.	Editor

OKLAHOMA WATER RESOURCES BOARD

James R. Barnett	Executive Director
Michael R. Melton	Assistant Director
Paul R. Wilson	Chief - Ground-Water Division
Duane Smith	Assistant Chief
Rick Smith	Chief-Planning
Dannie E. Spiser	Ground-Water Geologist
Norma S. Aldridge	Ground-Water Geologist

ACKNOWLEDGEMENTS

The cooperation and assistance of the personnel of the Oklahoma Water Resources Board is gratefully acknowledged. Appreciation is also extended to J. A. Wood, who was Ground-Water Chief during the development of this project.

TABLE OF CONTENTS

	Page
INTRODUCTION.....	1
Location.....	1
Previous Investigations.....	4
GEOLOGY.....	6
HYDROGEOLOGY.....	10
General.....	10
Water Table.....	10
Climate.....	10
Land Use and Irrigation.....	14
Surface Recharge.....	14
Natural Discharge.....	17
Irrigation Return Flow.....	17
Prior Appropriative Pumping Rates.....	20
Well Design and Well Yields.....	20
Coefficient of Permeability.....	25
GROUND-WATER QUALITY.....	31
GROUND-WATER MODELING.....	34
Simulation Procedure.....	34
Data Input.....	35
Bedrock and Historic Water-Table Elevations.....	37
Calibration.....	38
Simulation Period.....	41
RESULTS.....	45
Allocation.....	45
Ground-Water Quality.....	49
REFERENCE CITED.....	55
APPENDIX A - COMPUTER SIMULATION RESULTS.....	58
APPENDIX A-1 - COMBINED RESULTS FOR ENTIRE AREA.....	59
APPENDIX A-2 - RESULTS FOR ELK CITY PART A.....	68
APPENDIX A-3 - RESULTS FOR ELK CITY PART B.....	83

LIST OF FIGURES AND TABLES

Figure		Page
1	Location of Study Area by Counties.....	2
2	Location of Study Area by Township and Range.....	3
3	Computerized Structure Contour Map of the Base of the Elk City Sandstone (Part A).....	8
4	Computerized Structure Contour Map of the Base of the Elk City Sandstone (Part B).....	9
5	Annual Precipitation at Sayre, Oklahoma 1951-1980.....	12
6	Monthly Precipitation at Sayre, Oklahoma 1951-1980.....	13
7	Precipitation and Associated Well Hydrographs in Sections 11 and 17, T10N, R19W.....	15
8	Contoured (1973) Water Table Map of Digitized Computer Data (Part A).....	18
9	Contoured (1973) Water Table Map of Digitized Computer Data (Part B).....	19
10	Prior Rights Pumping for Irrigation (Part A).....	21
11	Prior Rights Pumping for Irrigation (Part B).....	22
12	Prior Rights Pumping for Municipal and Industrial Use (Part B).....	23
13	Average Well Construction for 200 gpm Pumping Rate.....	24
14	Well Yield (Part A).....	26
15	Well Yield (Part B).....	27
16	1973 Transmissivity (Part A).....	29
17	1973 Transmissivity (Part B).....	30
18	Flow Chart of Computer Modeling.....	36
19	Pattern Recharge (Part A).....	39
20	Pattern Recharge (Part B).....	40
21	Permeability Distribution (Part A).....	42
22	Permeability Distribution (Part B).....	43
	Twenty-Year Ground-Water Budget:	
23	Entire Area.....	46
24	Part A.....	47
25	Part B.....	48
26	1973 Saturated Thickness (Part A).....	50
27	1973 Saturated Thickness (Part B).....	51
28	1993 Saturated Thickness (Part A).....	52
29	1993 Saturated Thickness (Part B).....	53

Table		Page
1	Average Monthly and Annual Precipitation (Inches) for the Cities of Sayre.....	11
2	Calculation of the Percent of Rainfall That Goes to Ground-Water Recharge.....	16
3	Comparison of Water Quality.....	32

Project Title: Evaluation of Aquifer Performance and Water Supply Capabilities of The Elk City Aquifer in Washita, Beckham, Custer, and Roger Mills Counties, Oklahoma

Principal Investigator: Douglas C. Kent, Professor, Department of Geology, Oklahoma State University

Institution Funded: Oklahoma State University

Summary: The objective of this research was to determine the maximum annual yield of fresh water that can be produced from the Elk City Aquifer in Washita, Beckham, Custer, and Roger Mills Counties, Oklahoma. The determination of maximum annual yield was based on criteria established by Oklahoma ground-water law (82 Oklahoma Statutes Supp. 1973, Paragraph 1020.1 et seq) using computer simulation of all prior appropriate and subsequent allocated pumping over the entire aquifer area for twenty years (July 1, 1973 to July 1, 1993).

The total aquifer area was subdivided into two subareas: Part A and Part B. The combined maximum annual yield is 85,000 acre-feet proportioned as 0.9 acre-feet per acre over the total area. This was based on the following parameters: (1) the total area overlying the Elk City Aquifer is 164,000 acres, (2) the amount of ground-water in storage in the Elk City basin as of July 1, 1973 is 2,100,000 acre-feet, (3) the potential amount of water in storage plus return flow over the twenty-year life of the basin is 2,600,000 acre-feet, (4) the estimated rate of net recharge from rainfall is 2.78 inches per year and the assumed irrigation return flow rate is 15 percent, and (5) the initial average transmissivity is 6,100 gallons per day per foot and the average specific yield of the alluvium is 0.14. Natural pollution within the

Elk City Sandstone is negligible due to high water quality in the aquifer and lack of contributing streams within the area.

INTRODUCTION

General

The objective of the study was to determine the maximum annual yield of fresh water that can be produced from the Elk City Sandstone and the overlying unconsolidated materials. Under 82 Oklahoma Statute Paragraphs 1020.44 and 1020.5, enacted by the Oklahoma Legislature, the Oklahoma Water Resources Board is responsible for completing hydrologic surveys of each fresh ground-water basin or subbasin within the state of Oklahoma and for determining a maximum annual safe yield which will provide a 20-year minimum life for each basin or subbasin.

The maximum annual yield of each fresh ground-water basin or subbasin is based upon a minimum basin or subbasin life of 20 years from the effective date of the ground-water law (July 1, 1973). An annual allocation, in terms of acre-feet, is determined based on the maximum annual yield and is restricted to the aquifer area.

Location

The area of study is located mainly in Beckham and Washita Counties, with a small portion found in Roger Mills and Custer Counties (Figure 1). The exact location of the aquifer is shown in Figure 2. The total surface area of the aquifer is approximately 246 square miles. The aquifer has been divided into Parts A and B, as shown in Figure 2. The natural drainage has nearly severed the Elk City Sandstone exposing the underlying Doxey Shale.

The study area is defined by the continuous outcrop of the Elk City Sandstone in western Oklahoma. A few isolated outliers of the Elk City,

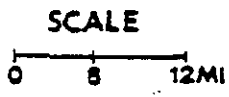
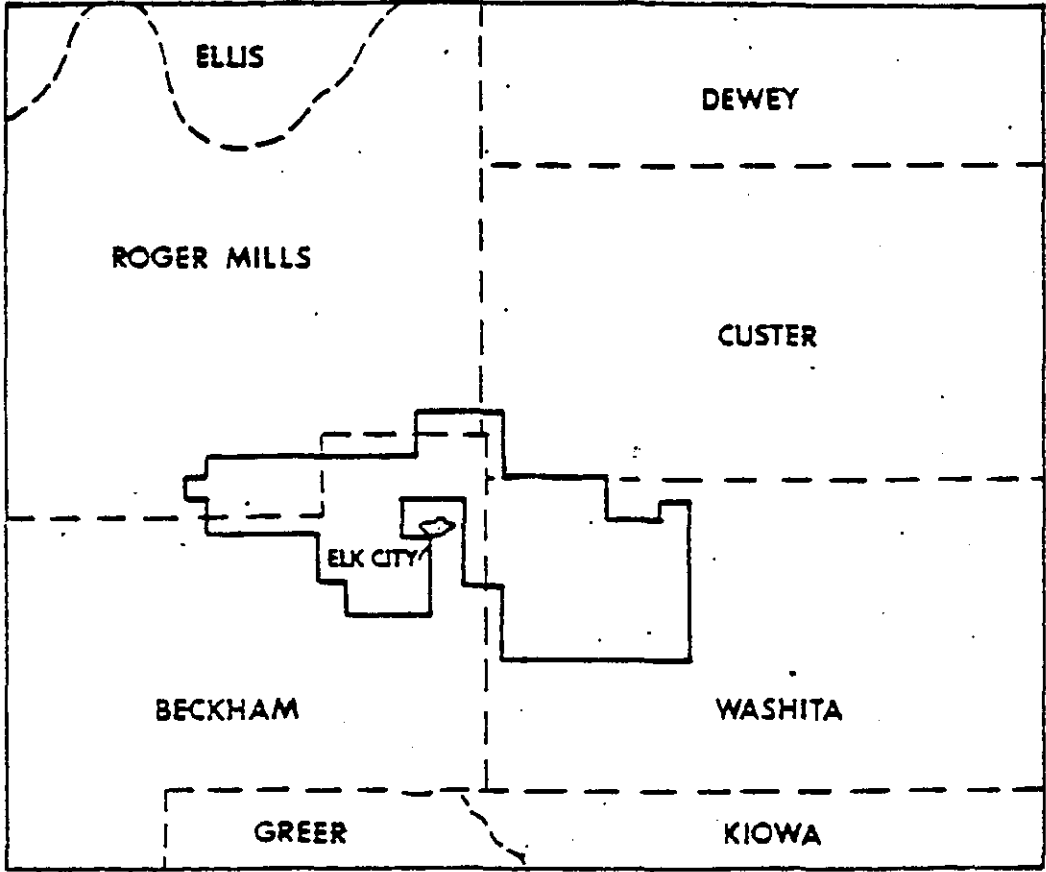

Figure 1. Location of study area by counties.

west of the study area, were not included with the Elk City Aquifer due to isolation and hydraulic discontinuity. The lateral boundary of the aquifer is surrounded by the underlying Dozey Shale except for outcrops of Tertiary age at the northwestern edge of the study area.

Previous Work

Smith (1964) mapped parts of Beckham and Roger Mills Counties in the vicinity of Elk City. His thesis was mainly an investigation which included mapping the stratigraphy of the area. The mapped area represents the western half of the area in this investigation.

Richardson (1970) studied the effects of the chemical solution of the Yellow Salt in western Washita County. He also produced a geologic map of the area. His thesis area corresponds to the eastern half of the study area. Zabawa (1976) studied the surficial structural geology of western Washita and eastern Beckham Counties. Her area encompasses most of the area in this report. The main purpose of her thesis was to show that many of the solution collapse features found in the area are related more to major subsurface faults rather than to the solution collapse exclusively. The relative age and mapping of these surficial faults was determined from geologic data.

In 1964, Palmquist and Koopman investigated the occurrence and availability of ground water in northwestern Washita County. The purpose of their study was to determine if a sufficient water supply could be established for the Clinton-Sherman Air Force Base. Their study corresponds to the eastern half of the study area. Much of the data from their report was used in modeling the Elk City Aquifer.

Kent (1978, 1980) studied the alluvium and terrace deposits along the North Fork of the Red River for water supply capability. Kent used

the 1974 computer model version developed by the U.S. Geological Survey to determine maximum annual yield and annual allocation of those aquifers. Many of the hydrogeologic and modeling techniques used by Kent (1980) were used in this investigation.

Bredehoeft and Pinder (1970) and Pinder (1970) designed a basic mathematic model to simulate two-dimensional aquifer problems. This model has been modified several times. Witz (1978) modified the model for a multilayered system and developed new input-output options for the IBM 370-158. The 1974 version of this model developed by the U.S. Geological Survey plus the later modifications were used in this study.

GEOLOGY

The Elk City Aquifer is delineated by the outcrop of the Elk City Sandstone which is overlain by younger sediments and is underlain by the Doxey Shale.

The Doxey Shale underlies the Elk City Sandstone. It consists of blocky, maroon shale and maroon siltstone. An undulating topography occurs where the resistant siltstone of the Doxey Shale outcrops on hill crests. The thickness of the formation ranges from 160 to 195 feet.

The Elk City Sandstone represents the uppermost Permian unit in the Anadarko Basin and is the main lithologic unit of the aquifer under study. Earlier reports have indicated a maximum thickness of 220 feet for the Elk City Sandstone. A maximum thickness of 260 feet was noted in the northeast part of the study area using well data.

The Elk City is a very friable sandstone, being lightly cemented by clay, calcite, gypsum, and/or iron oxide. The iron oxide gives the formation a reddish color. Due to its friable property, the sandstone is very erodible; thus, only a few good outcrops of the sandstone can be found.

Three types of unconsolidated sediments overlie parts of the Elk City Sandstone. Sediments of what appear to be Late Tertiary in age are found in the western half of the study area (Part A). In the eastern half (Part B), Quaternary terrace deposits and stabilized sand dunes overlie the Elk City Sandstone and have been mapped by Richardson (1970). The Tertiary sediments are composed of sand and weakly cemented sandstone. The maximum thickness of these deposits is approximately 170 feet. The age of these sediments was determined on the basis of correlation with known Pliocene beds and fossil evidence. The deposits

are lithologically similar and time-equivalent to the unconsolidated sediments in the Ogallala Formation found northwest of the study area. The terrace sediments include undifferentiated deposits. Some of the terrace deposits consist of clay and silt, while other terraces are composed of multicolored sands and gravels. A remnant of a buried channel exists in the central area (Palmquist and Koopman, 1964). The buried channel trends south-southeast and is filled with coarse alluvial sediments. The deposits in the buried channel reach a maximum thickness of 65 feet. The overall average thickness of the terrace deposits is between 10 and 15 feet. The sand dunes are stabilized by vegetation and consist of aeolian sand.

In order to describe the boundaries of the aquifer, a structure contour map was prepared for the base of the Elk City Sandstone. Water well data, provided by the Oklahoma Water Resources Board, and a surface structure map by Zabawa (1976), were used to develop the structure contour map shown in Figures 3 and 4. The natural and model boundaries of the aquifer are shown.

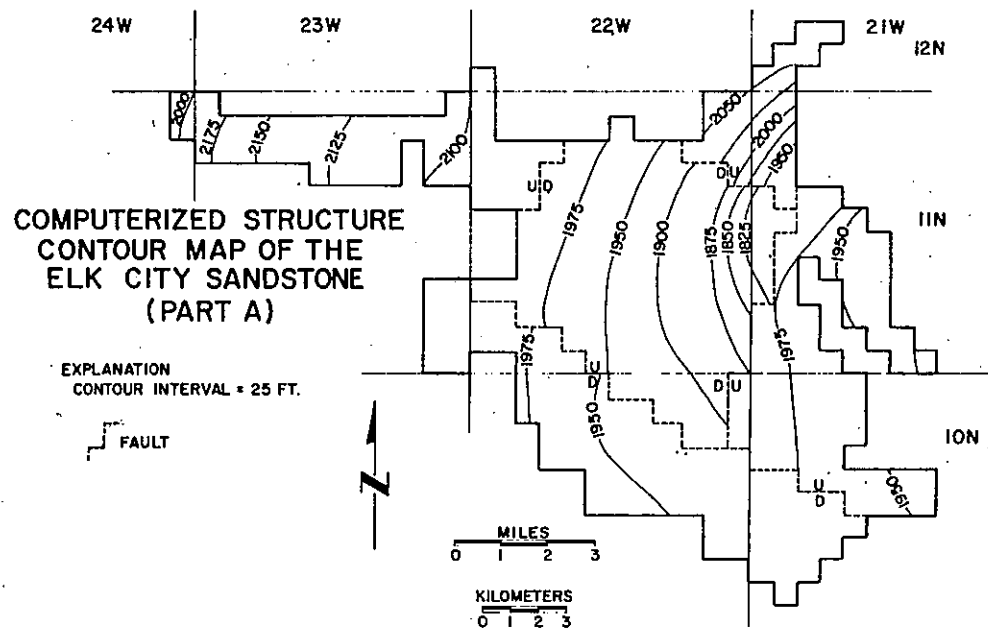

Figure 3. Computerized structure contour map of the base of the Elk City Sandstone (Part A)

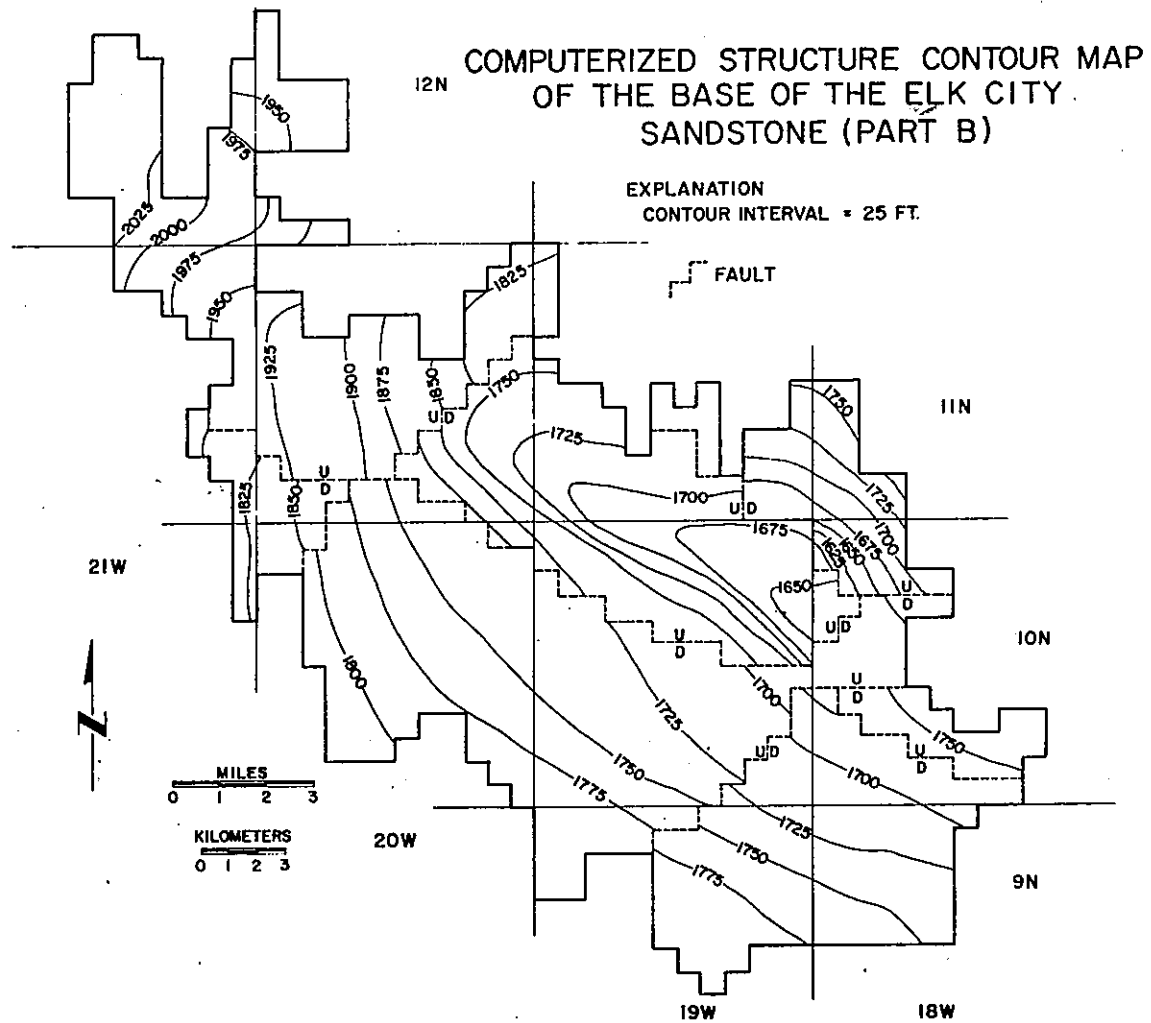

Figure 4. Computerized structure contour map of the base of the Elk City Sandstone (Part B)

HYDROGEOLOGY

General

The Elk City Aquifer is an unconfined aquifer. The Elk City Sandstone is located in the area along the northwest-trending divide between the Washita and Red River basins and it forms a topographic high. The underlying Doxey Shale serves as an aquiclude; the impermeable nature of the Doxey prevents a downward loss of water and restricts available ground water to the overlying sandstone.

Due to its high topographic position, a series of springs and seeps occur at the contact of the Elk City Sandstone and Doxey Shale. The water lost from seeps and springs reduces the saturated thickness of the Elk City Sandstone around the edge of the aquifer.

Water Table

The upper boundary of the Elk City Aquifer is formed by a water table. The water table generally follows the topography of the area. The water table gradient is generally low except near the edges where seeps and springs are associated with steeper gradients.

Climate

The area is characterized by a semi-arid climate. The mean annual temperature at Burns Flat is 58.8°F. and the frost-free period averages about 200 days a year (Palmquist and Koopman, 1964). Precipitation varies within the study area. Average monthly and annual precipitation for the cities of Sayre, Elk City, and Clinton are shown in Table 1. Precipitation amounts decline westward toward Sayre, Oklahoma. Annual and monthly precipitation amounts are also shown in Figures 5 and 6 for the period 1951-1978 at Sayre, Oklahoma. The highest precipitation

Table 1

AVERAGE MONTHLY AND ANNUAL PRECIPITATION (INCHES)
FOR THE CITIES OF SAYRE, ELK CITY, AND CLINTON

Time Unit	Sayre	Elk City	Clinton
January	.64	.73	.80
February	.86	1.00	1.06
March	1.17	1.35	1.52
April	2.11	2.33	2.70
May	4.04	4.65	4.80
June	3.57	3.33	3.81
July	2.33	2.41	2.50
August	1.92	2.10	2.97
September	2.25	2.11	2.69
October	2.34	2.30	2.65
November	.89	1.07	1.26
December	.85	.87	1.04
Annual	22.97	24.25	27.08

ANNUAL PRECIPITATION AT SAYRE, OKLAHOMA 1951-1980

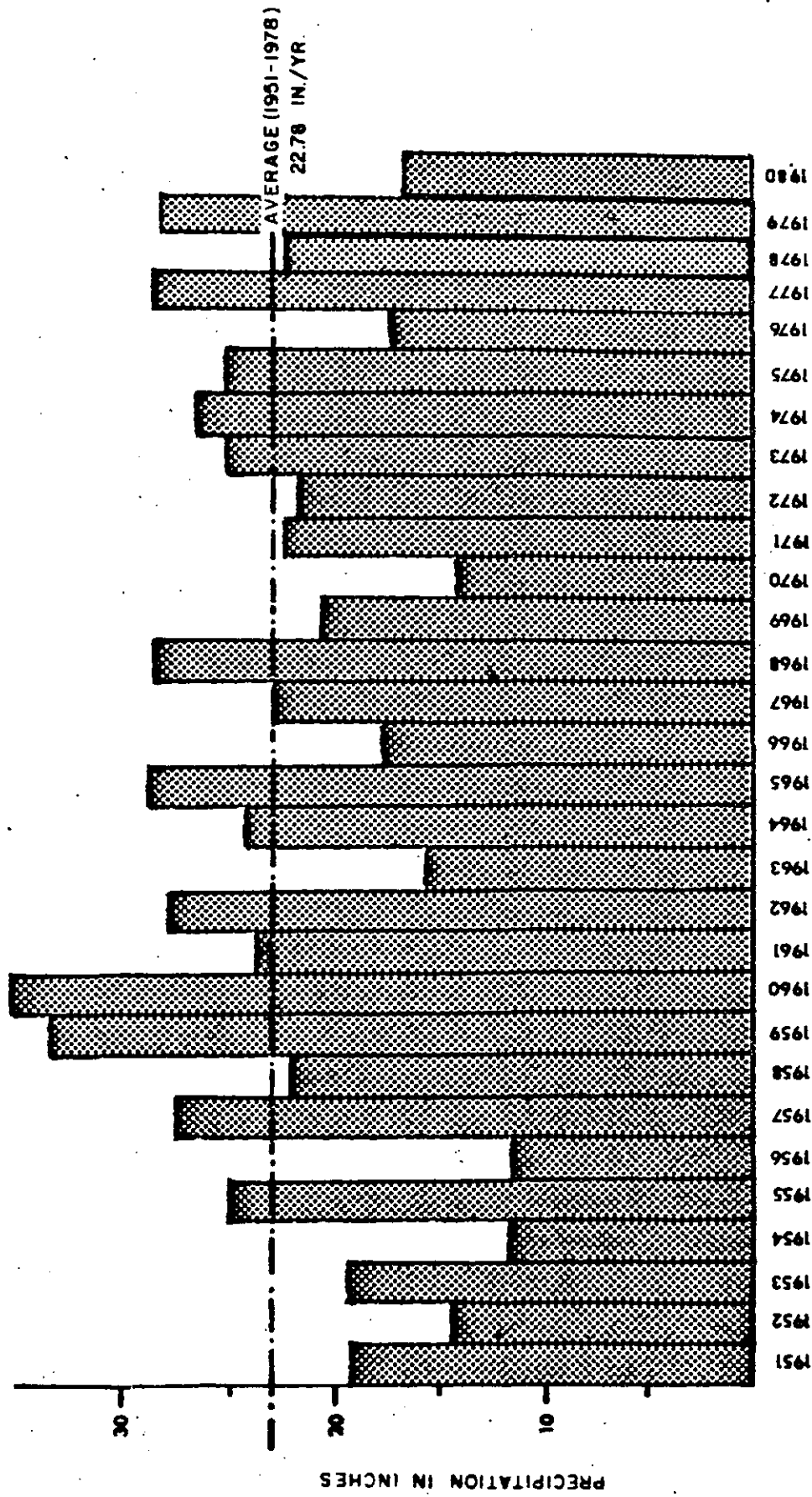

Figure 5. Annual Precipitation at Sayre, Oklahoma 1951-1980

MONTHLY PRECIPITATION AT SAYRE, OKLAHOMA 1951-1980

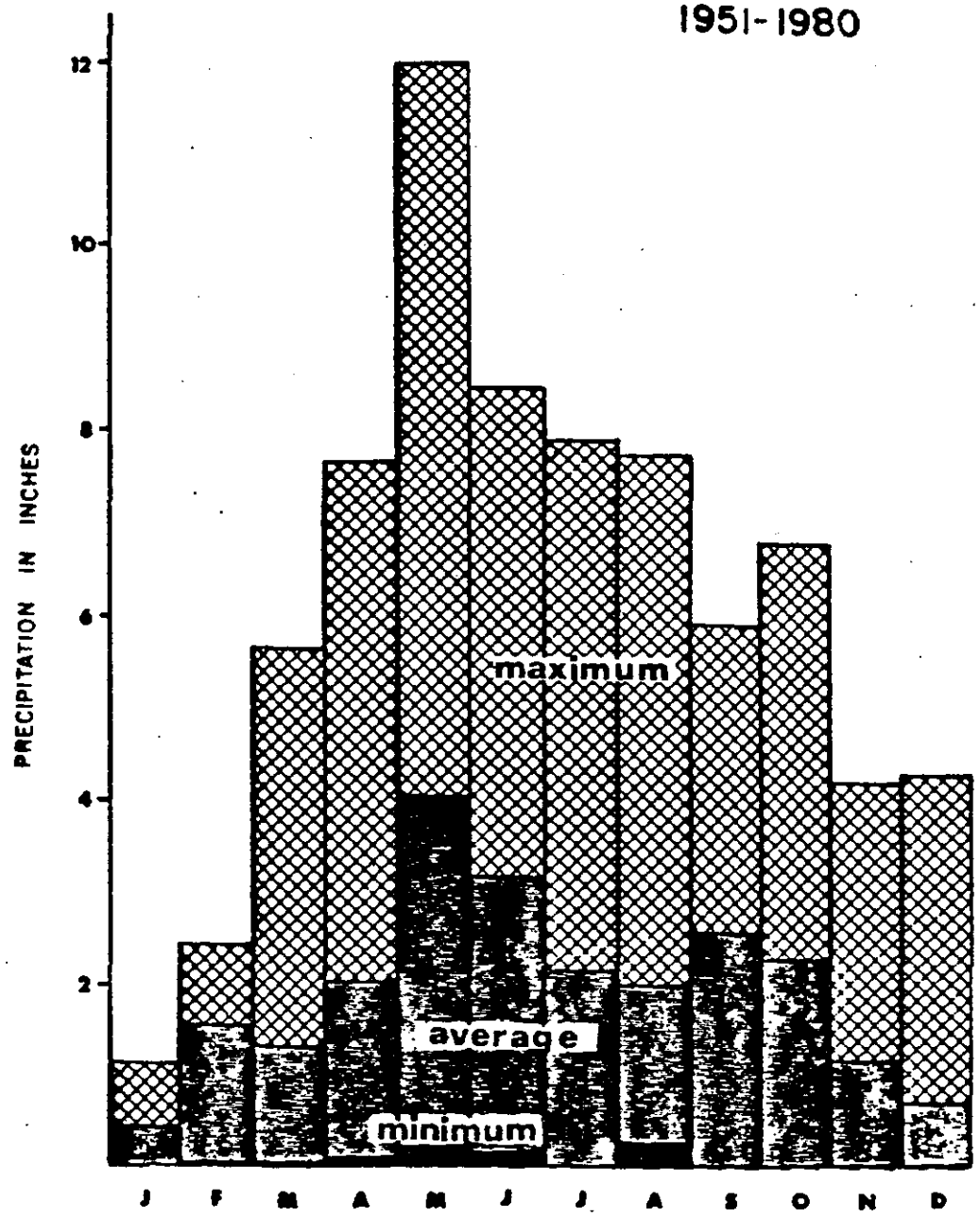

Figure 6. Monthly Precipitation at Sayre, Oklahoma 1951-1980.

occurs in May and lowest is in January.

Land Use and Irrigation

The upland plains in the study area are used mostly for raising cotton and wheat. The soils covering the edges of the uplands and the dissected lowlands are considerably less productive and are used for pasture (Palmquist and Koopman, 1964). The few irrigation wells found in the area are mostly used to irrigate cotton in June, July, August, and September. Some wells in the study area are used for municipal water.

Surface Recharge

The ground-water aquifer is recharged mainly by precipitation in the area. Recharge will vary depending upon the many factors which affect rainfall and evapotranspiration. These factors include rainfall intensity and duration, vegetation, soil type, unsaturated zone, permeability, temperature, wind, topography, and depth to water table. Sandy soil in conjunction with flat topography and poor drainage inhibits runoff and enhances infiltration; therefore, a higher percentage of rainfall recharges the aquifer. The recharge from deep percolation of precipitation is estimated to be 14.1 percent of the total rainfall. The estimate is based on precipitation frequency-magnitude records for the area as shown in Figure 7. The calculation of recharge percentage is shown on Table 2. The amount of rainfall percolating into the aquifer can be calculated by determining the change in water level from the well hydrographs for each storm and multiplying the amount of water level change by specific yield. The percent of rainfall that recharges the ground-water reservoir is calculated by dividing the inches of recharge by total rainfall of each

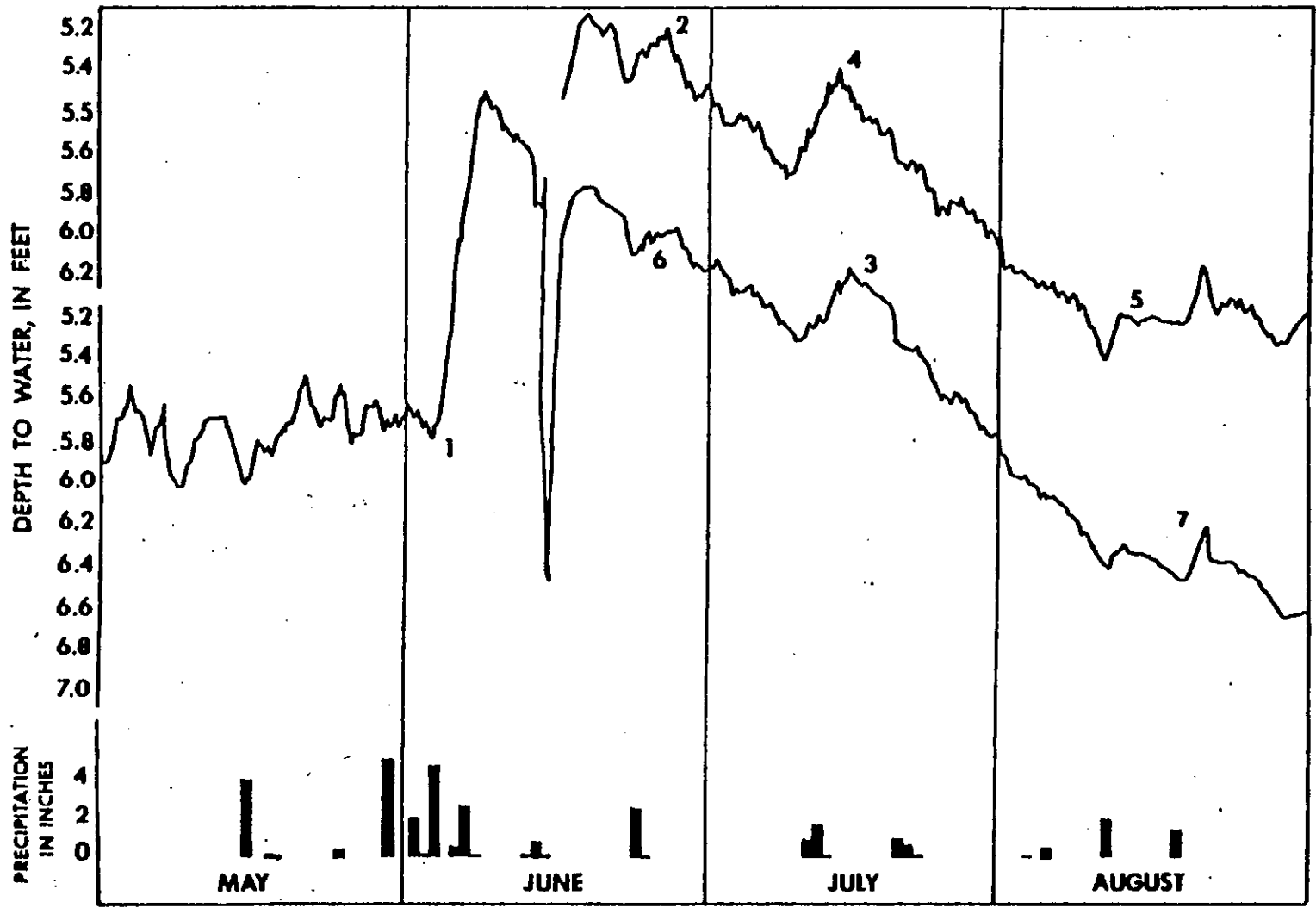

Figure 7. Precipitation and associated well hydrographs in Sections 11 and 17, T10N, R19W.

Table 2

CALCULATION OF THE PERCENT OF RAINFALL THAT GOES TO GROUND-WATER RECHARGE

Storm Event#	Change in Water Table (Inches)		Average Specific Yield (SY)		Gross Inches of Rainfall as Recharge		Total Rainfall of Storm (Inches)		Percent of Rainfall as Recharge
1	18.00	x	.21	=	3.78	÷	15.4	=	24.5%
2	1.32	x	.21	=	.28	÷	2.4	=	11.6%
3	2.4	x	.21	=	.50	÷	3.0	=	16.8%
4	2.64	x	.21	=	.55	÷	3.0	=	18.5%
5	1.44	x	.21	=	.30	÷	3.0	=	10.1%
6	1.08	x	.21	=	.27	÷	3.0	=	7.6%
7	1.08	x	.21	=	.23	÷	2.4	=	9.5%
Mean									14.1%

storm. The 14.1 percent recharge rate was determined by averaging the recharge rates for all storms.

Natural Discharge

Natural loss of ground water from the aquifer occurs by discharge to streams, springs, and evapotranspiration. Discharge through springs and seeps occur along the contact between the Elk City Sandstone and Doxey Shale. The flow of the springs range from less than 1 gpm to as much as 50 gpm (Palmquist and Koopman, 1964). The rates will vary seasonably due to fluctuation of the water table caused by precipitation changes. Evaporation and transpiration (or evapotranspiration) are important factors to be considered for a shallow water table aquifer in a semi-arid climate. These two factors have been combined together because of the difficulties in computing transpiration alone. Evapotranspiration is included in the computation of total discharge.

A recharge-discharge equilibrium apparently has been established in the aquifer. In referring to the data on the initial water-table map (Figures 8 and 9), it is noted that a negligible change in water levels has occurred since 1964. When recharge is high due to high rainfall, discharge is increased proportionally along the seeps and springs near the edge of the aquifer. It is assumed that this equilibrium will be maintained unless the aquifer is stressed by significant pumping. Existing pumping appears to have a negligible affect on the equilibrium.

Irrigation Return Flow

Return flow from irrigation, an important secondary source of recharge, has been estimated at 15 to 25 percent of pumping based on studies by the Oklahoma Water Resources Board in 1957 and others. Return flow from irrigation was estimated to be 15 percent based on the

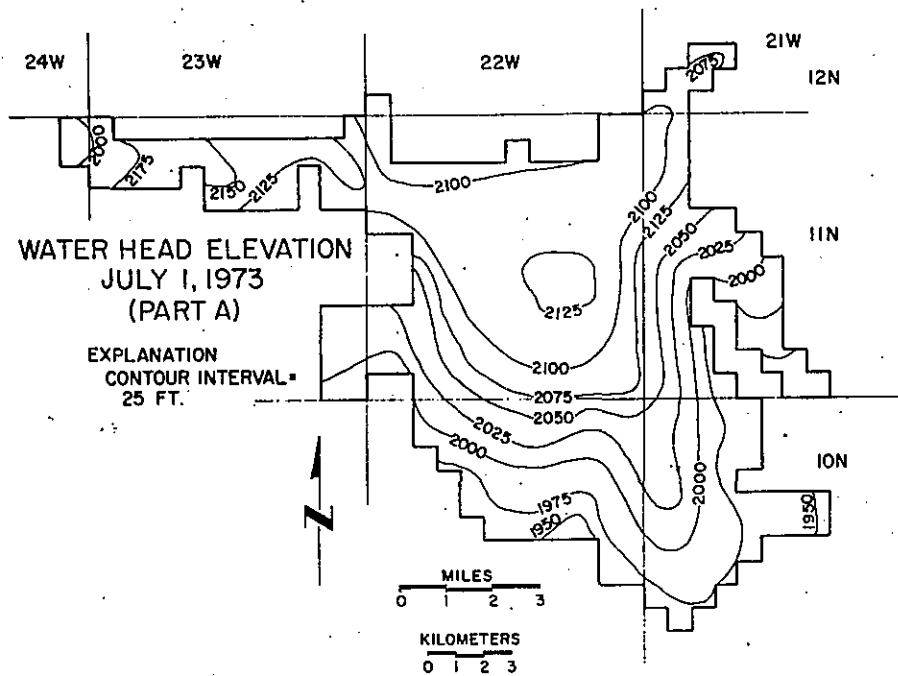

Figure 8. Contoured (1973) water table map of digitized computer data (Part A).

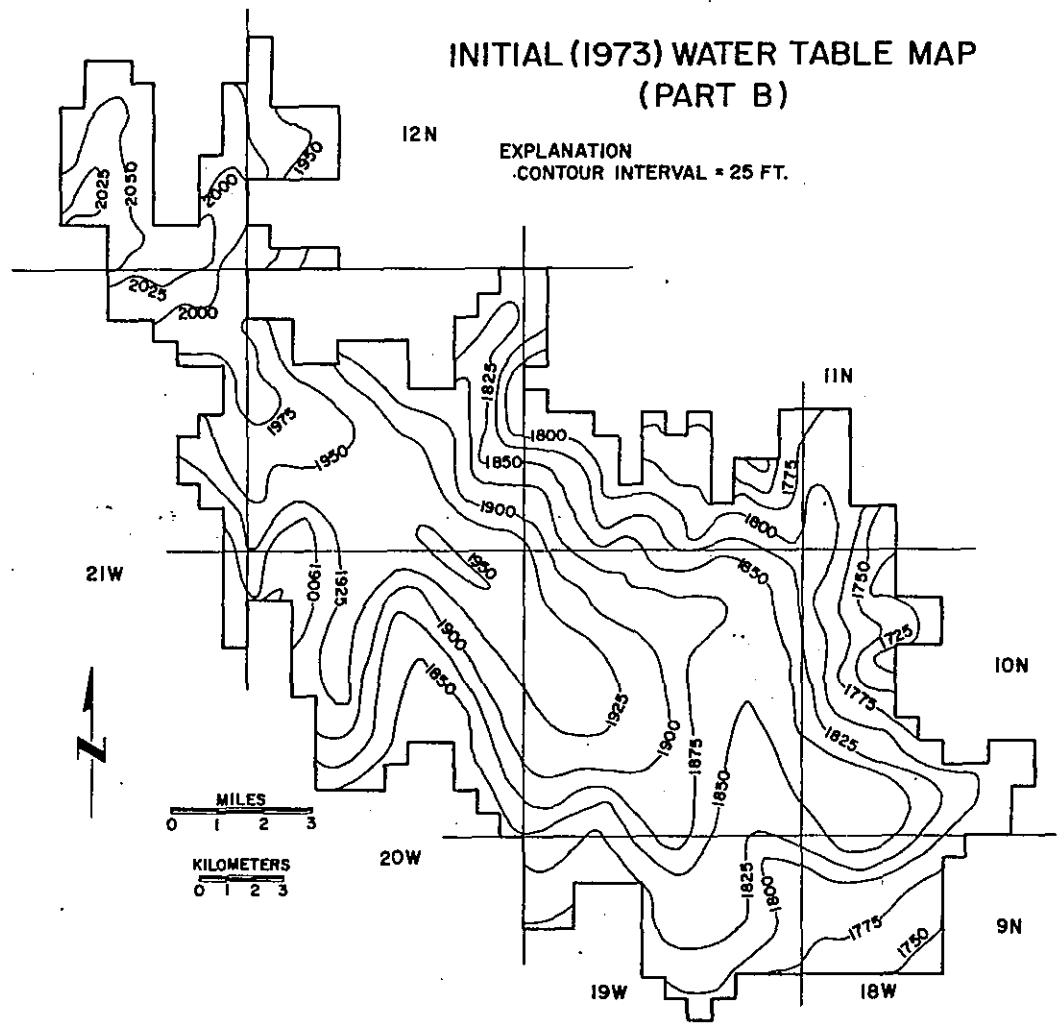

Figure 9. Contoured (1973) water table map of digitized computer data (Part B).

water budget analysis and evapotranspiration estimates.

Prior Appropriative Pumping Rates

Data was acquired and used by the Oklahoma Water Resources Board to prepare the final orders establishing prior appropriative pumping rates. These data were used to initialize pumping rates in the model simulation and are shown in Figures 10 and 11.

Municipal and industrial uses of ground water are restricted to Part B as shown in Figure 12. It is assumed that most of the prior appropriative pumping for irrigation occurs during the four months of June through September.

Well Design and Well Yields

Wells in the study area average 160 feet in depth and may or may not be cased in the sandstone below the unconsolidated surficial deposits. Only the larger wells used for irrigation or public supplies have been cased, perforated, or have commercial well screens. Also, most of these wells have a gravel pack (Palmquist and Koopman, 1964). Gravel packing, casing, and screened intervals are recommended for future well development. Construction design for an average well capable of producing 200 gpm is shown in Figure 13. Well design will vary from location to location depending on the saturated thickness and permeability at each location.

The minimum saturated thickness for simulated pump withdrawal of water from a well, which is designed in accordance with the one shown in Figure 13, is determined by considering the well yield and the corresponding screen length required to accommodate the well yield. The well yield was determined using a formula expressing well yield as a function of drawdown and specific capacity with respect to discharge

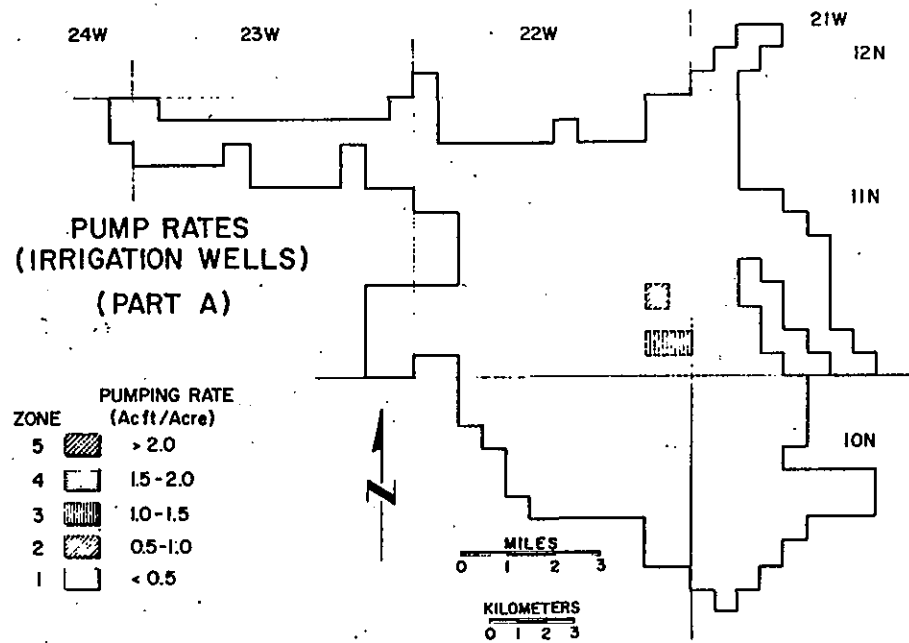

Figure 10. Prior rights pumping for irrigation (Part A).

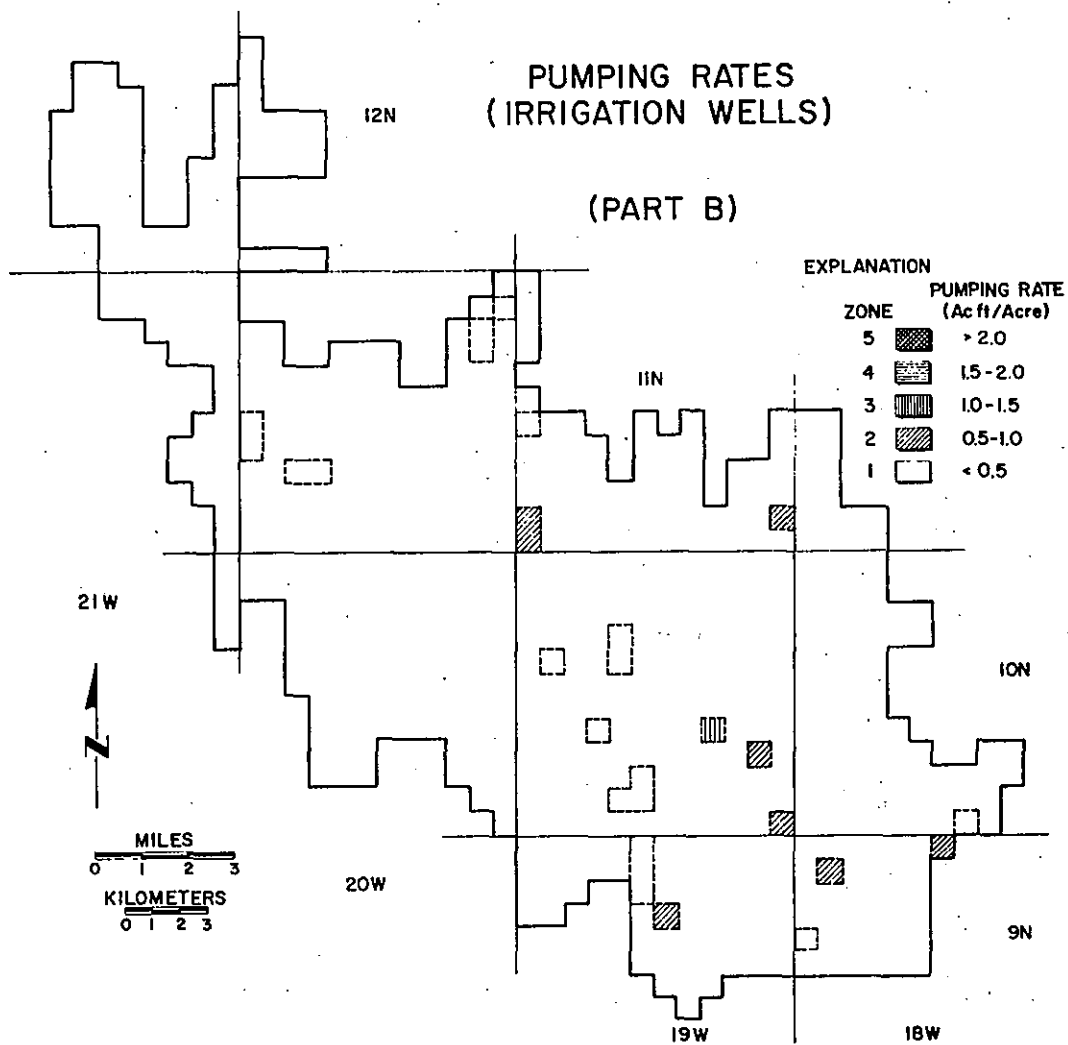

Figure 11. Prior rights pumping for irrigation (Part B).

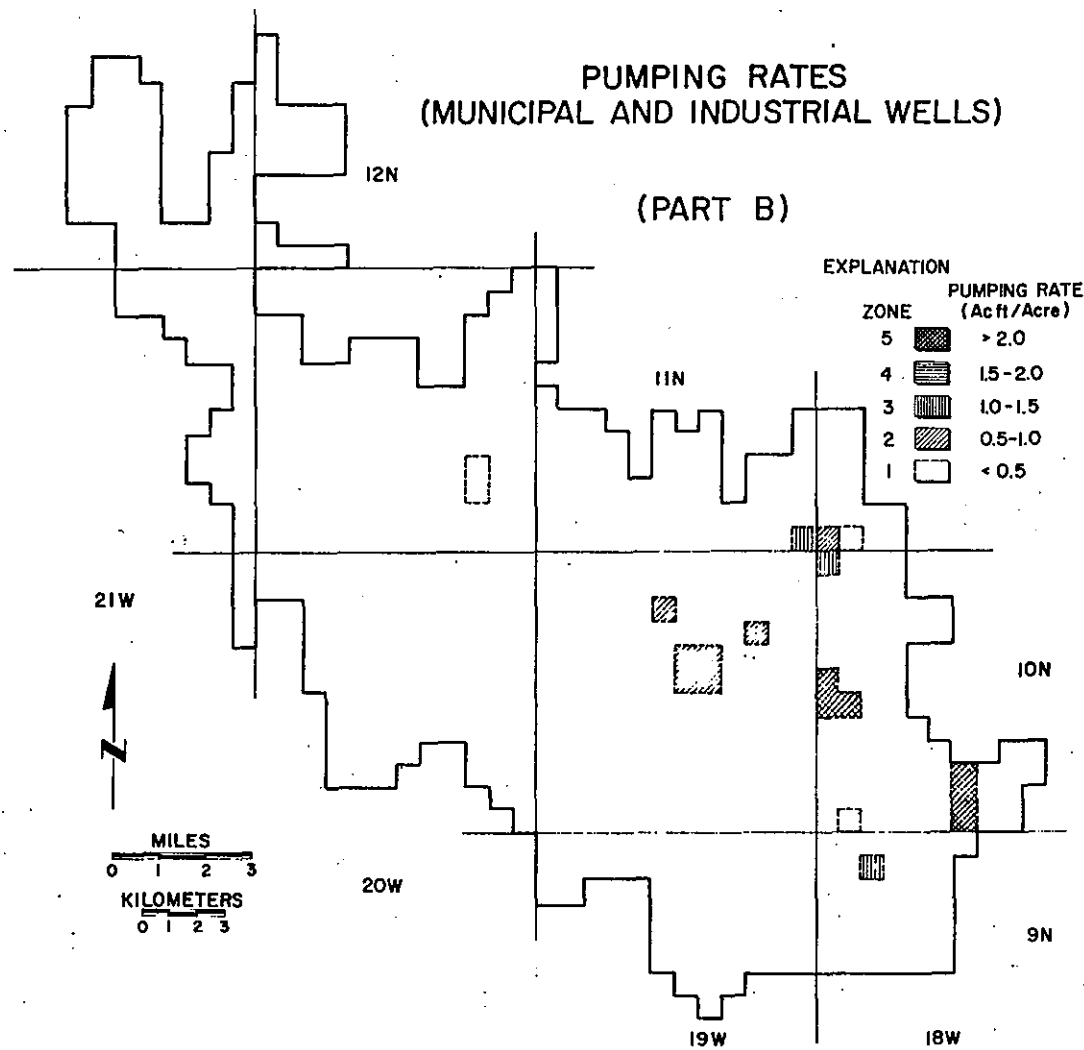

Figure 12. Prior rights pumping for municipal and industrial use (Part B).

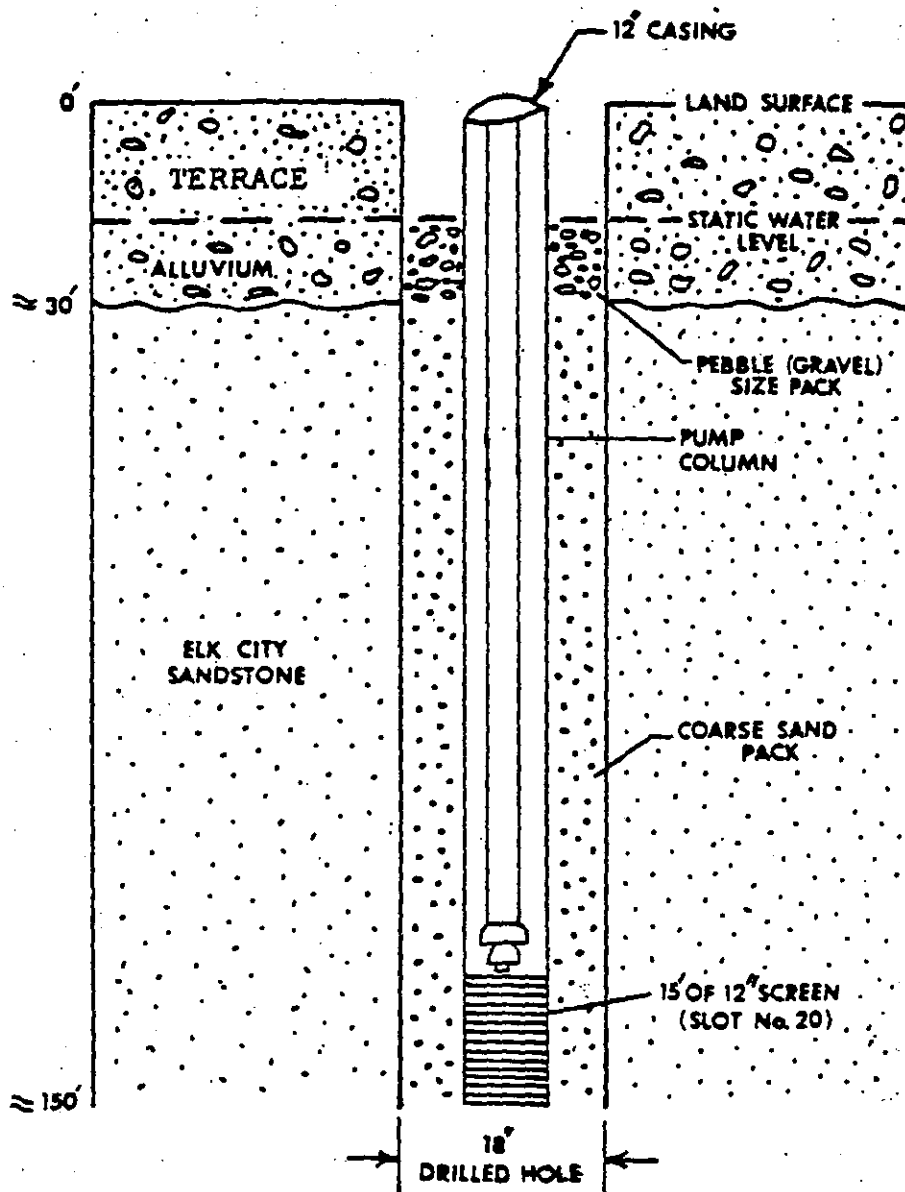

Figure 13. Average well construction for 200 gpm pumping rate.

rate (Walton 1970). The well yield for Parts A and B are shown in Figures 14 and 15. Nodes with well yields of 200 gpm or greater were assigned a well screen length of 15 feet (Figure 13). The remaining area with well yields less than 200 gpm were assigned a well screen length of five feet. Screen length was based on a formula expressing screen length as a function of well radius, discharge rate, and screen slot size. The average well yields in Parts A and B where the well yield exceeds 200 gpm are 1,107 gpm and 1,272 gpm respectively; whereas well yields average 57 gpm in Part A and 123 gpm in Part B where the well yield is less than 200 gpm.

Coefficient of Permeability

The Elk City Sandstone constitutes the major part of the aquifer. This fine-grained sandstone is relatively homogeneous with respect to its grain size. The sandstone is primarily friable but some zones are more cemented by calcium carbonate. Laboratory permeabilities range between 0.2 and 24 gpd/ft². Field permeabilities were obtained from aquifer tests which were conducted by Palmquist and Koopman (1964). The average field permeability of the Elk City Sandstone is approximately 50 gpd/ft². The higher values obtained from the aquifer tests can be explained by the presence of an extensive joint system in the Elk City Sandstone. Jointing can be noted in the sandstone outcrops. The study of the relationship between the concentration of joint patterns and permeability has not been made. Consequently, the Elk City Sandstone is assumed to be a fractured homogeneous sandstone aquifer with an average permeability of 50 gpd/ft².

The transmissivity is a function of both saturated thickness and the coefficient of permeability. Therefore, transmissivity is variable

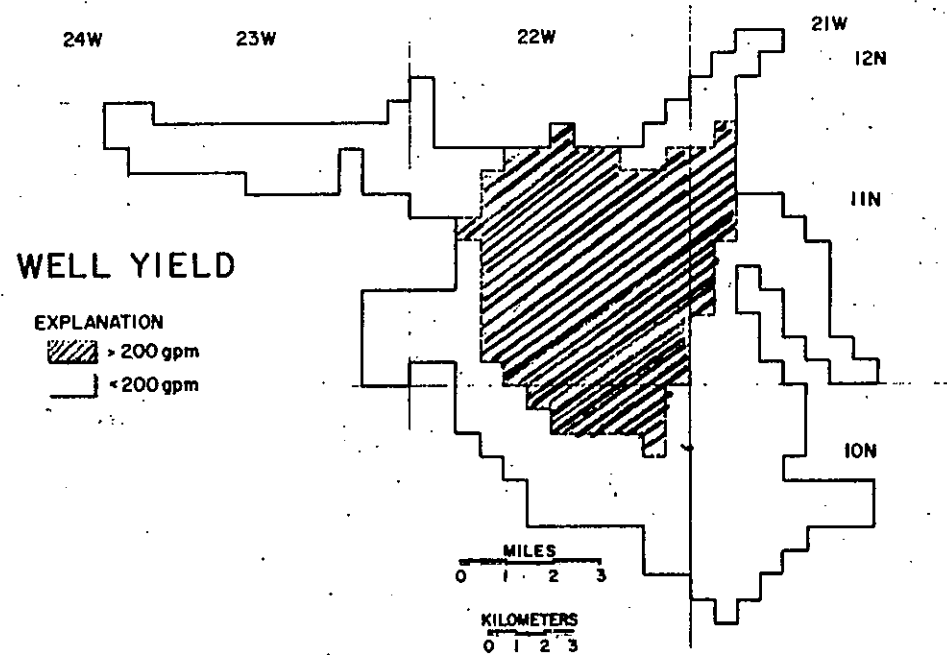

Figure 14. Well yield (Part A).

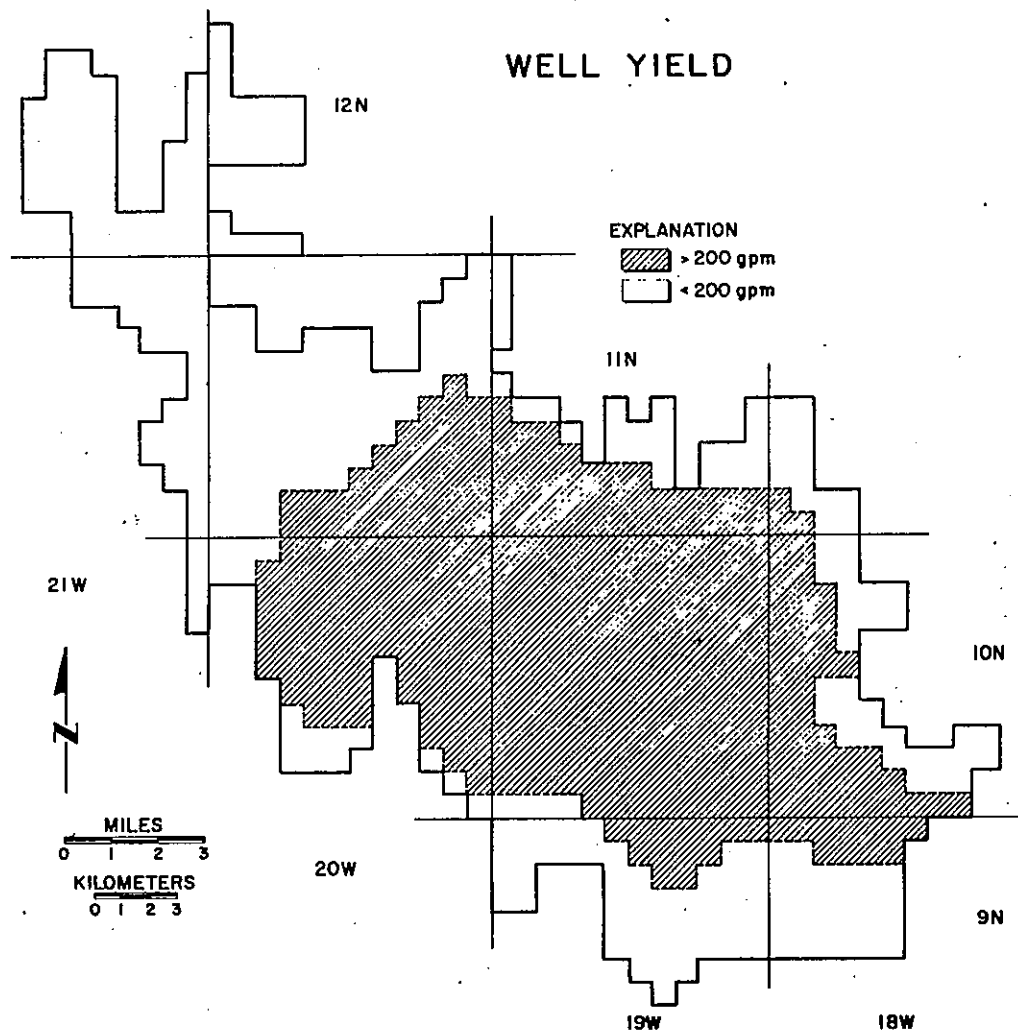

Figure 15. Well yield (Part B).

over time as the aquifer is depleted. The average saturated thickness in Part A is 83 feet and 94 feet in Part B. The average permeability in Part A is 55 gpd/ft² and 62 gpd/ft² in Part B. Using these values the average transmissivity of each part can be computed. The average transmissivity of Part A is 5,000 gpd/ft and it is 6,400 gpd/ft in Part B. However, transmissivity will vary throughout the aquifer due to the variable thickness of the aquifer and to the variable permeability caused by the local occurrence of more permeable overlying Tertiary-Pliocene deposits. Variation of the initial transmissivity in Parts A and B are shown in Figures 16 and 17.

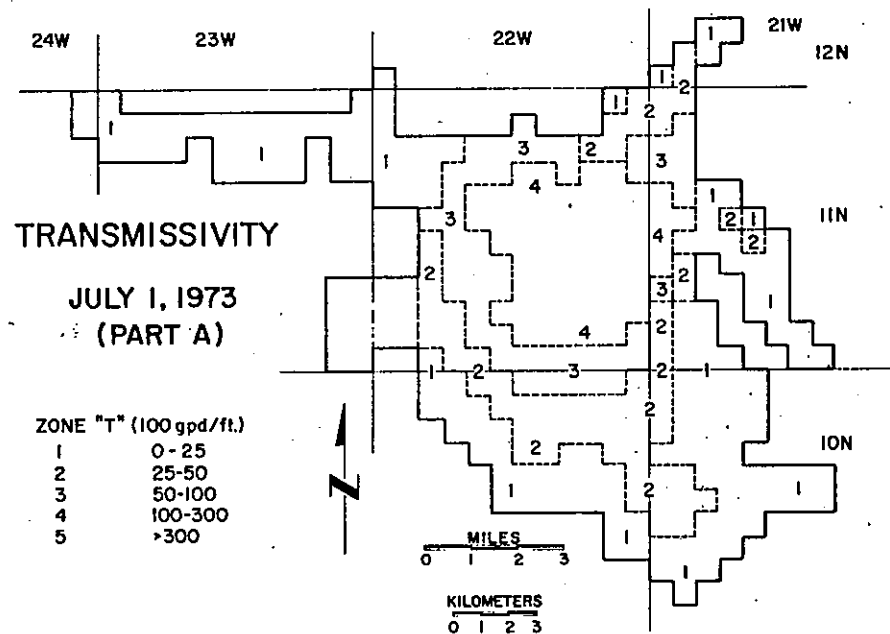

Figure 16. 1973 transmissivity (Part A).

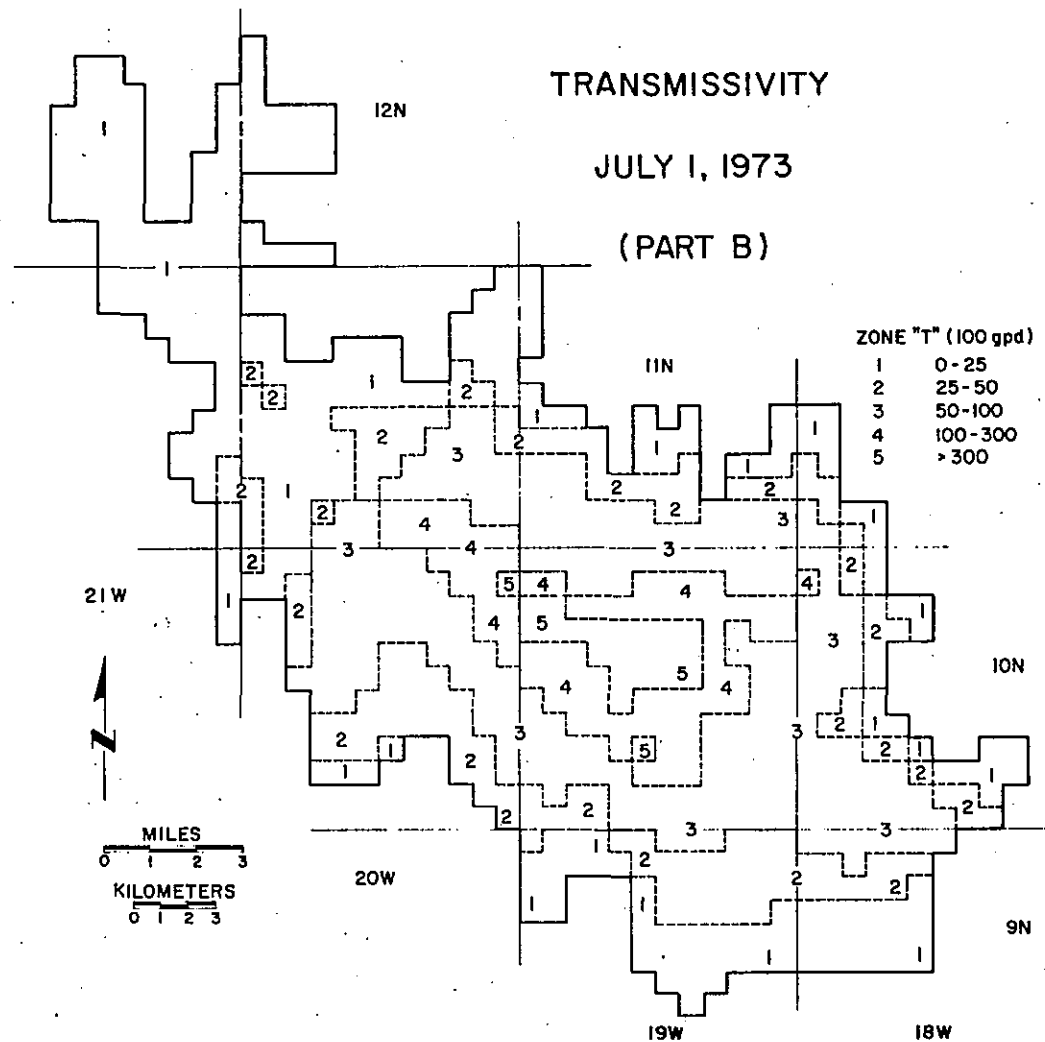

Figure 17. 1973 transmissivity (Part B).

GROUND-WATER QUALITY

Planning for development of a water supply requires information on the chemical quality of the water (Palmquist and Koopman, 1964). The ground-water chemistry depends on the initial rain water quality and the chemical reactions which may occur during downward percolation through the aquifer. The kinds and amounts of dissolved minerals are a function of the rock type and the length of time the water is in contact with those rocks. The ground water may also be subject to contamination from surface pollutants that percolate down into the aquifer.

The mean total dissolved solids (TDS) of the ground-water in the Elk City Aquifer is 467 parts per million (ppm). This is based on data from Palmquist and Koopman (1964) and Al-Shaieb (1980). Moderately high concentrations of calcium (70 ppm) and bicarbonate (321 ppm) were also noted. The Elk City Sandstone is cemented primarily by calcium carbonate (CaCO_3) which provides the source for the calcium (Ca^{++}) and bicarbonate (HCO_3^-) ions in the ground water. These concentrations contribute to the relatively high levels of hardness in the ground-water. A comparison of the water quality in the Elk City Sandstone, Rush Springs Sandstone, and surface water which occur in the study area, is shown in Table 3.

The mean TDS of 467 ppm of the Elk City Aquifer is considerably lower than what is characteristic of ground water in other Permian rocks located in the Anadarko Basin. For example, an average TDS of 1,800 ppm is typical for ground water occurring in the Doxey Shale and Cloud Chief Formation (Al-Shaieb, 1980). The higher values can be attributed to the occurrence of evaporites in the Permian red beds.

TABLE 3
COMPARISON OF WATER QUALITY

OCCURRENCE	AVERAGE CONCENTRATIONS (in ppm)					
	TDS	HCO ₃	Ca	NA	Cl	SO ₄
Elk City Sandstone	467	321	70	30	35	20
Rush Spring Sandstone	1,000	-	-	-	21	504
Surface water in the study area	530	340	74	20	40	46

Localized pollution may occur from either a nitrate source or brine-water source. Sources of nitrate contamination may be barnyard refuse, sewage, or possibly nitrogen fertilizer applied on agricultural lands (Palmquist and Koopman 1964). Sources of brine-water contamination generally occur as a result of oil-field operations including salt water injection or as a result of downward percolation of brine water from abandoned mudpits or brine impoundments.

GROUND-WATER

MODELING

Simulation Procedure

Initial ground-water levels, pumping rate, and transmissivity are primary variables used in the model of the aquifer. Quantitative values must be assigned to the hydrogeologic aquifer in order to model the aquifer within the accuracy of the data used. The quantitative values are either assigned directly by the hydrogeologist or generated by the computer model. A value for each hydrogeologic parameter is assigned to every quarter mile section (node) in the aquifer. The model output consists of a mass balance and estimated volume of ground water in storage, as well as maps of predicted ground-water table elevations and saturated thicknesses at 5-year intervals throughout the 20-year minimum basin life. The total aquifer area is 246 square miles. Due to the areal extent and dissection by drainage, the aquifer was subdivided into Part A and Part B as shown in Figure 2. The areal extent of the parts are: Part A, 75 square miles; Part B, 171 square miles. The model was applied to each of the parts.

The modeling program used in this investigation was originally written by Pinder (1970) and revised by Trescott, Pinder, and Larson (1976). The finite difference model simulates ground-water flow in two dimensions for an artesian aquifer, a water table aquifer, or a combination of the two. The water table version was used on the Elk City Aquifer. The program was later modified for a multilayered permeability system. The multilayered approach was used due to the significant differences in permeability caused by the occurrence of

different types of sedimentary deposits.

The approach used to process the data for model simulation is shown by the flow diagram in Figure 18. The input data were divided into matrix and constant parameters (Figure 18). The matrix parameters include water-table elevations, land, top, and bedrock elevation; river bed thickness and hydraulic conductivity; and well pumping and recharge rates. These matrix parameters were collected for the study area and mapped, contoured, and digitized over each of the parts. A grid spacing of one-half mile was used to represent quarter sections to establish a matrix. The storage coefficient of the river bed is a constant parameter and the coefficient of permeability of the aquifer was considered variable or constant based on availability of data.

Contoured data was gridded and digitized for input into the computer model. A quarter mile grid, drawn at the same scale as the base maps, was overlain onto each contoured map. Values were assigned to each node of the grid by a perimeter-averaging technique developed by Griffen (1949). Griffen's method involves averaging the values at the corners and center of each node to obtain an average value for that node.

Data Input

Data input refers to all data used in the model. Data are read into the model as either single constants or variables in matrix format. The data which are used as single constants are:

1. Recharge rates from precipitation and irrigation;
2. Evapotranspiration rates.

Recharge occurs in three forms; precipitation, subsurface inflow, and return flow from irrigation.

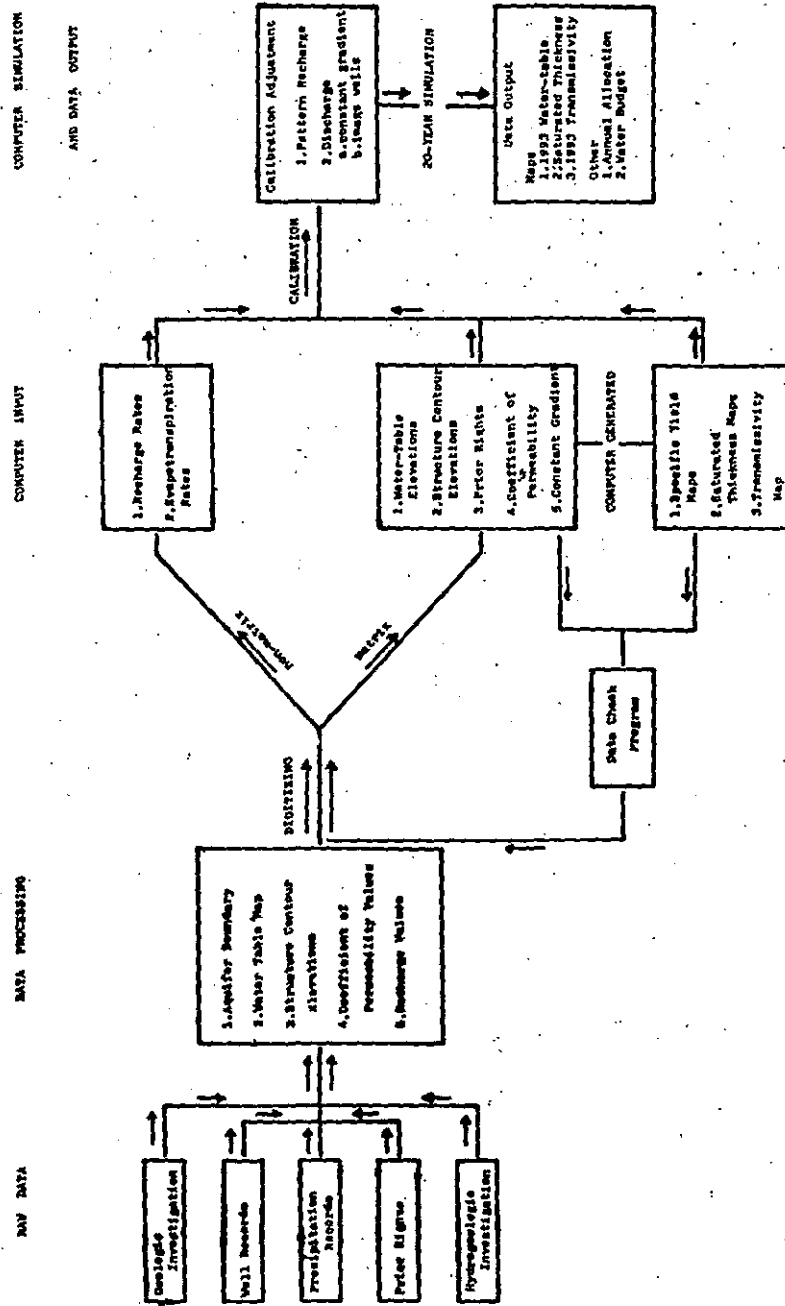

Figure 18. Flow chart of computer modeling.

Initial recharge rate from precipitation was calculated to be 14.1 percent of precipitation (Table 2). Precipitation varies east to west. The precipitation recorded at Sayre will be used for the western part (Part A) and the precipitation recorded at Clinton will be used for the eastern part (Part B). The rainfall data is represented in Table 1. The procedure for determining recharge is described on page 14. Computed recharge rates for the two areas are:

1. Western part: $22.92 \text{ in.} \times 14.1\% = 3.24 \text{ in.}$
2. Eastern part: $27.80 \text{ in.} \times 14.1\% = 3.92 \text{ in.}$

These initial values were changed during calibration, which is discussed under calibration. Return flow from irrigation is estimated as 15 percent of the total water pumped and is initially subtracted from the amount of water pumped in each model simulation.

The evapotranspiration rate could not be obtained from hydrogeologic data. Because the aquifer is assumed to be in a recharge-discharge equilibrium, the evapotranspiration was incorporated in the net recharge which was finally determined by subsequent calibration.

Bedrock and Historic Water-Table Elevations

An average land elevation was identified for each quarter section and assigned to each node using 15 minute U.S.G.S. quadrangle topographic maps. Water-table and bottom elevations of the aquifer were assigned to each node using a water-table map (Figures 8 and 9) and structure contour map of the base of the Elk City Sandstone (Figures 3 and 4), respectively. For modeling purposes, the surface of the Doxey Shale at the base of the Elk City Sandstone was considered to be an impermeable boundary.

Calibration

An initial recharge rate was calculated from well hydrographs and precipitation frequency magnitude records (Table 2). The natural recharge rate varies due to many factors as described earlier. Refinement of the recharge rate was incorporated in the initial calibration in the form of pattern recharge. Pattern recharge consists of dividing the aquifer into parts that have relatively the same recharge characteristics. The two main recharge characteristics that were used to develop pattern recharge were soil type and topography. By identifying soil types and drainage within each part, quantitative values based on relative percolation rates can be assigned to those parts.

Two distinct recharge areas are found in Part A (Figure 19). The recharge areas correspond to the lithologic and soil differences in the area. The Tertiary-Pliocene deposits represent one area and the soil derived from Elk City Sandstone represent the other area. Due to the flat topography and permeable soils of the Pliocene deposits, a recharge rate which is higher than the initial recharge estimate was assumed. A recharge of four inches per year was used where Pliocene deposits exist. A recharge rate of two inches per year was established for the remaining area (Figure 19) which consisted of better drainage and thinner, less permeable soils. The weighted average of the two recharge rates was the same as the originally assigned values.

Part B is also represented by two recharge areas (Figure 20). The flat upland Quaternary terrace deposits represent one recharge area with the recharge rate equivalent to the originally estimated recharge of 14.1 percent of rainfall or 3.92 inches. The other calibrated subarea

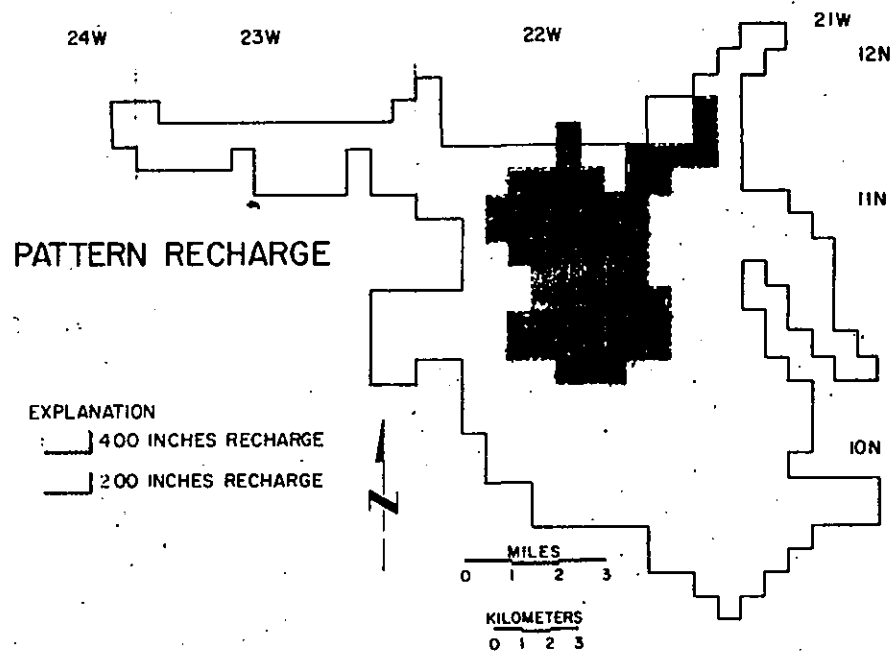

Figure 19. Pattern recharge (Part A).

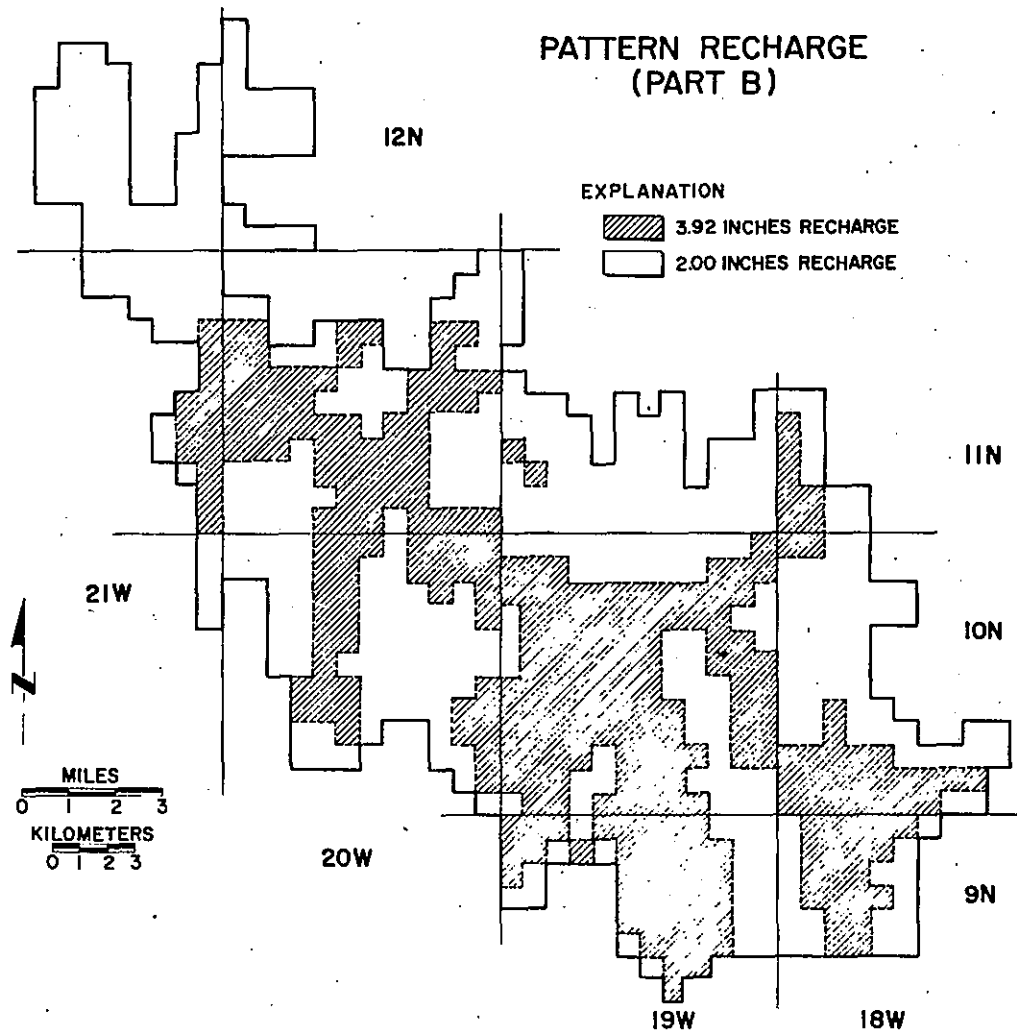

Figure 20. Pattern recharge (Part B).

in Part B has the same recharge characteristics as the less permeable area of Part A (2 inches). The weighted average of the two recharge rates is slightly lower than the originally assigned value.

After the initial calibration using pattern recharge was accomplished, the discharge was calibrated to remove anomalies and to further refine recharge-discharge equilibrium. The initial one-year calibration resulted in an appreciable rise in the water table near the constant gradient nodes located at the edge of the aquifer. Apparently the water could not be sufficiently drained by the constant gradient nodes. It was noted that ground-water drainage coincided with perennial streams existing in the area. Water was not sufficiently discharged into the streams and removed from the ground-water system. In order to increase the discharge into perennial streams, a series of image wells were placed on the nodes where the perennial streams were located.

Other excessive rises in the water table occurred between the contact of Elk City Sandstone and the more permeable overlying sediments. Image wells were used to simulate small springs or seeps which are expected to occur at the contact of the unconsolidated material and Elk City Sandstone. The location of the image wells is found around the boundary of saturated unconsolidated material (Figures 21 and 22). After making final adjustments of the image wells, an equilibrium condition was achieved and model calibration completed.

Simulation Period

The model was used to simulate pumping and corresponding water-level changes over a one-year and a 20-year period. The one-year simulation run was used to calibrate the model. Twenty-year simulation runs were initiated on July 1, 1973 and terminated on July 1, 1993. The

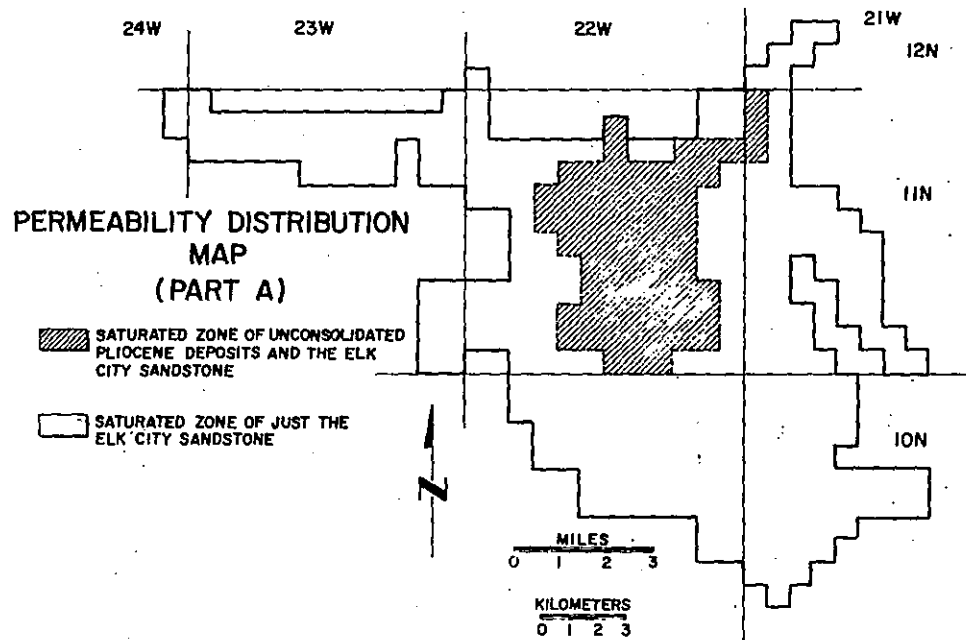

Figure 21. Permeability Distribution (Part A).

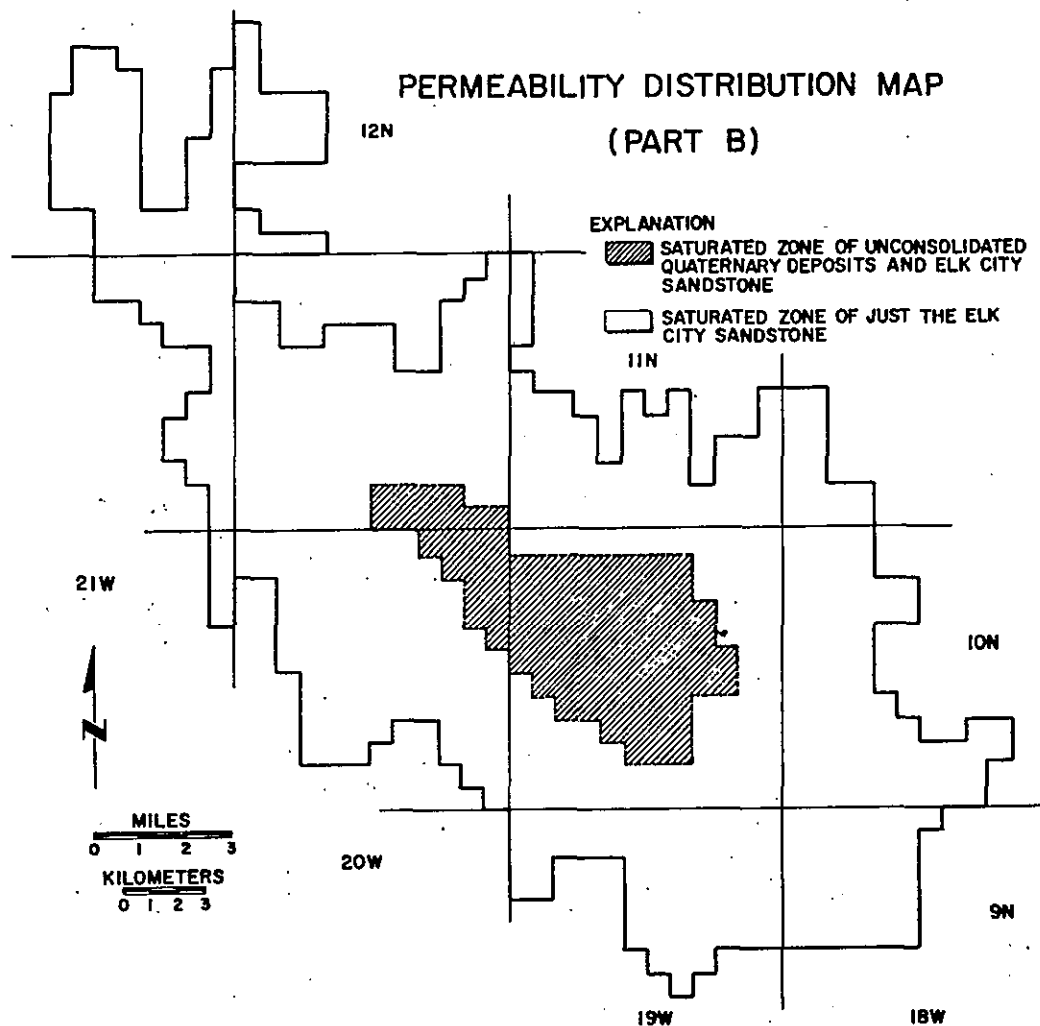

Figure 22. Permeability Distribution (Part B).

longer simulation period is based on Oklahoma Water Law Statute 82, Paragraphs 1020.4 and 1020.5 which require that the new annual pumping allocations be assigned based on a minimum aquifer life of 20 years.

The 20-year simulation included two simulation runs: (1) prior appropriative rate only (Figures 10, 11, and 12); (2) prior appropriative rates combined with allocation assigned to all other nodes.

RESULTS

Allocation

The final 20-year computer simulation was conducted for the 1973 to 1993 period for each subbasin using pumping rates of prior appropriative right owners. This simulation was repeated with allocation pumping in conjunction with prior appropriative pumping.

Maximum annual yield was determined by adjusting the amount of allocated pumpage that would cause 50 percent of the nodes to go dry by the end of the simulation period (20 years). The maximum annual yield and allocated pumpage was optimized by repeated 20-year simulations to obtain the required 50 percent dry area. A saturated thickness of five feet was considered dry due to size limitations of screen length and size of a submersible pump which would be set at the bottom of a fully penetrating well capable of pumping 300 gallons per minute. A maximum annual yield of 85,000 acre-feet and an average annual allocation of 0.91 acre-feet per acre were determined.

The annual allocation of 0.91 acre-feet per acre was determined for the entire area by averaging the computed allocations for each subbasin and using a weighted factor based on the percent of total aquifer area occupied by each subbasin. A 20-year ground-water budget was computed for final computer allocation runs of each part and of the entire aquifer area (Figures 23, 24, and 25). In addition, a detailed ground-water budget analysis and ground-water distribution summaries for the two subbasins (Parts A and B) are shown in Appendix A.

Each node (160 acres) was pumped continuously for a 4-month period during the summer of each year at three times the annual allocation rate. This schedule was continued throughout the 20-year period unless

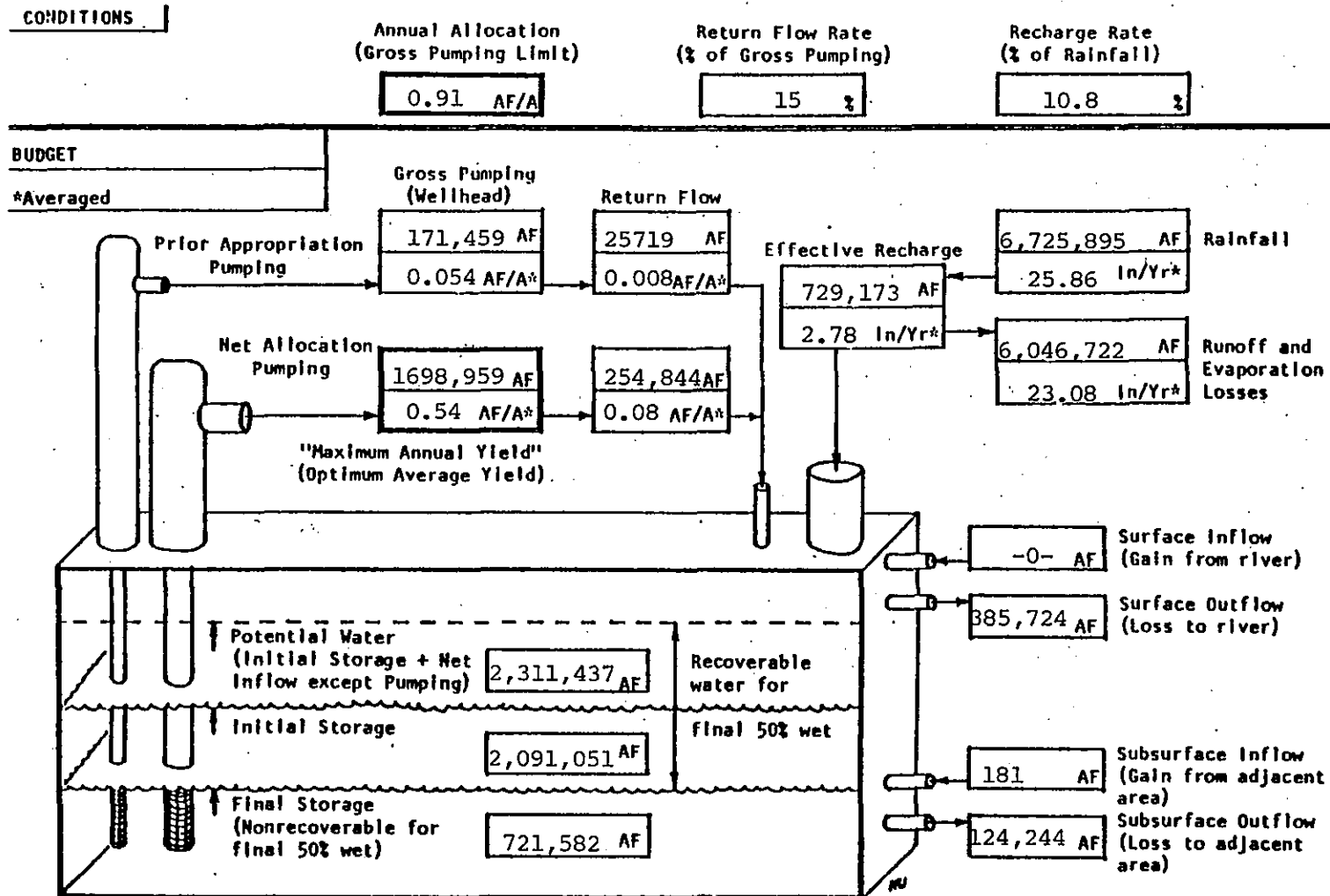

Figure 23. Water budget. (parts A and B) (after Kent, 1980).

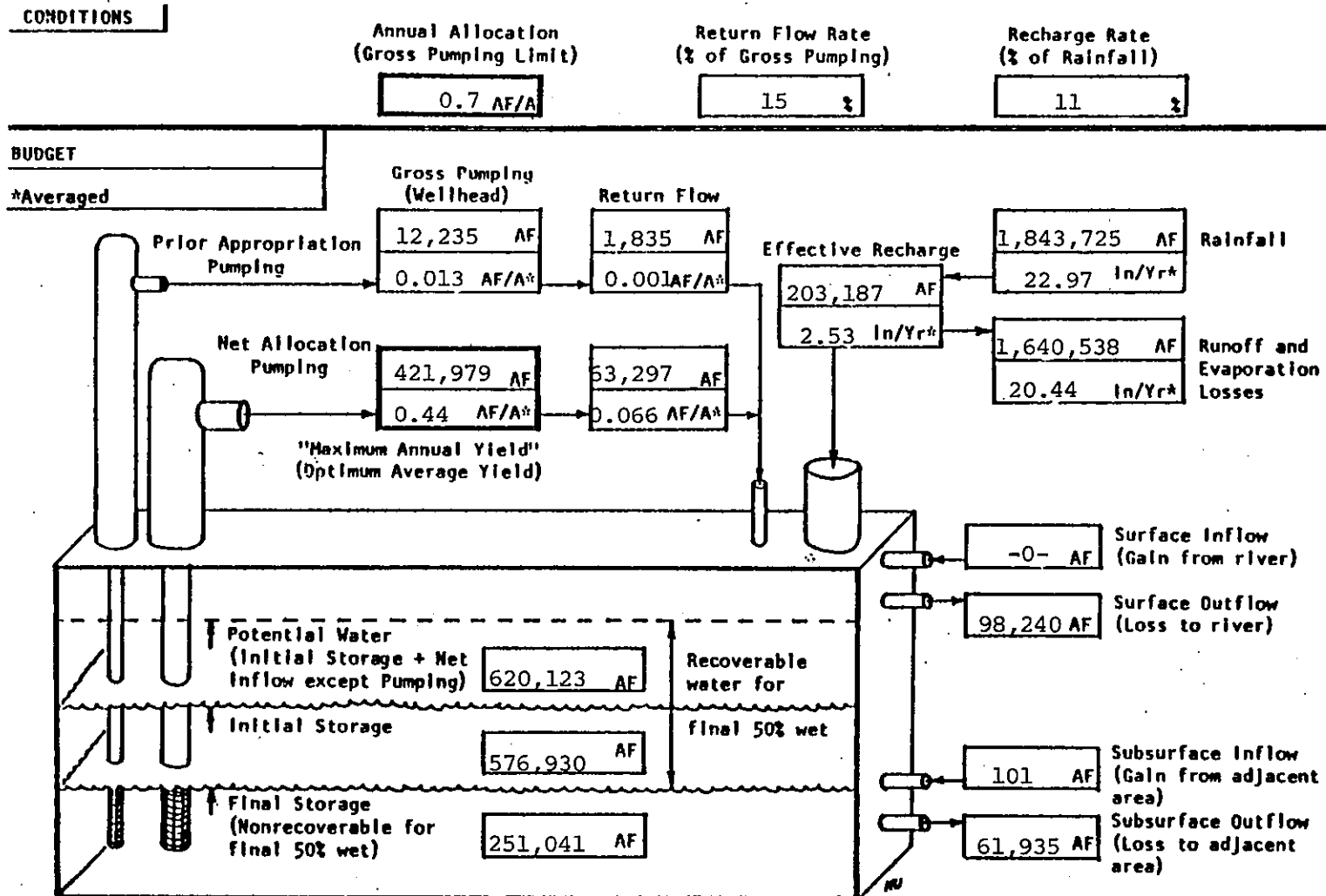

Figure 25. Water budget (part A) (after Kent, 1980).

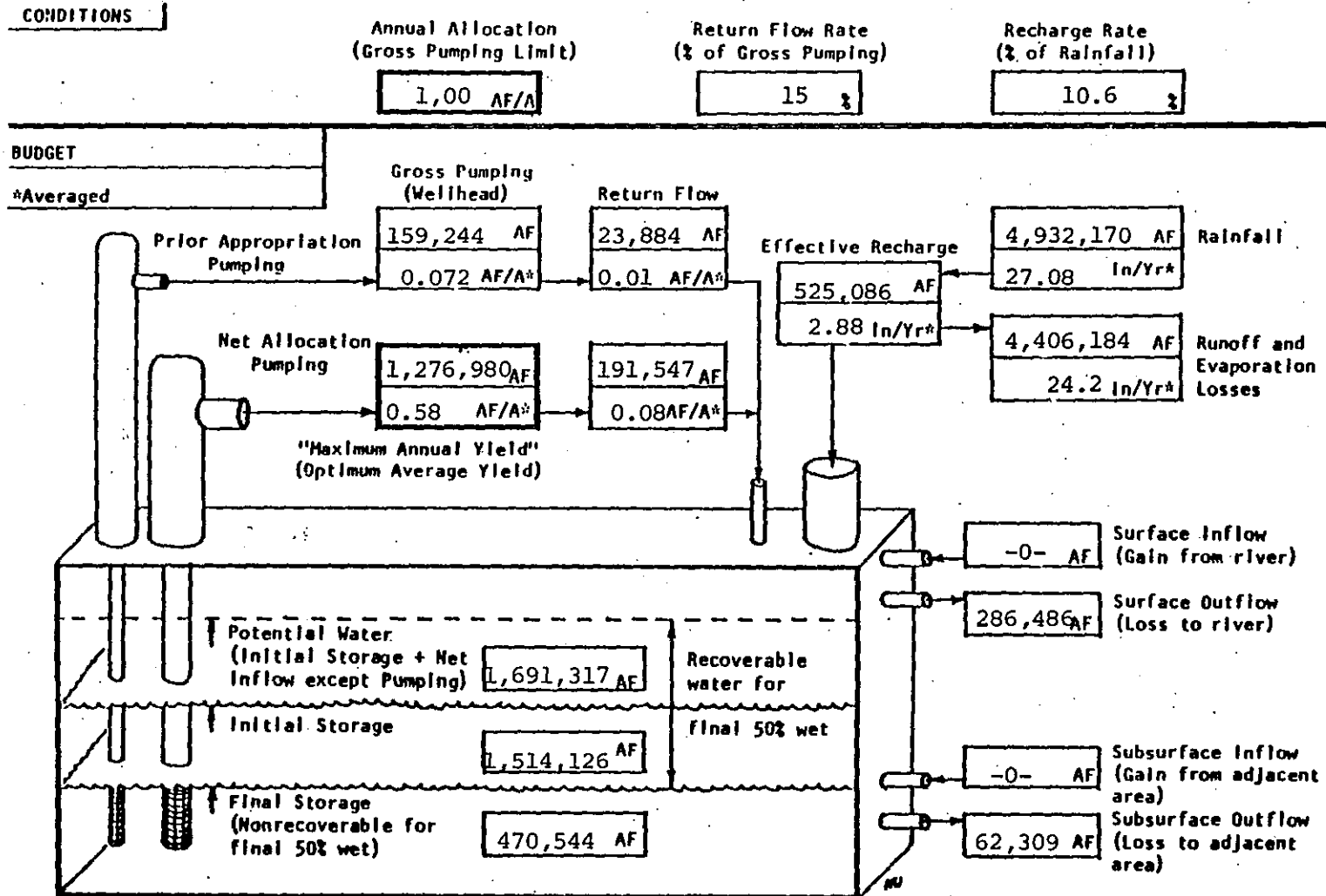

Figure 24. Water budget (part B) (after Kent, 1980).

the node became dry prior to that time. It is assumed in the model that everyone pumps the average maximum legal limit (0.91 acre-feet per acre). This rate corresponds to an instantaneous pumping rate of approximately 300 gallons per minute continuously pumped for the 4-month period between June 1 and September 30 of each year. Under these conditions, various parts of the area go dry at different times. This is due to the non-homogeneous nature of the alluvium (variable transmissivity and corresponding specific yield). The 50% dry criteria was used to accommodate this variability. The wells are turned off in the model when the 5-foot saturated thickness is reached and will turn on periodically to remove accumulation due to recharge. The maximum annual yield is the resulting amount of water recovered over the 20-year period during which wells are being turned off and on as the aquifer is depleted and recharged. Because of these factors, the maximum annual yield does not simply equal the product of allocation rate times the area.

The computer simulation results are summarized in the ground-water budgets shown in Figures 23 to 25. Simulated changes in saturated thickness and areas that become dry within each part (Part A and Part B) for 1973 and 1993, are shown in Figures 26 to 29. Other computer simulation results for the same time interval include saturated thickness for intervening periods and water depth (Appendix A).

Ground-Water Quality

The quality of the ground-water in the Elk City Aquifer and related surface water is very similar. This similarity supports the assumption that the surface water is being recharged by aquifer and that the

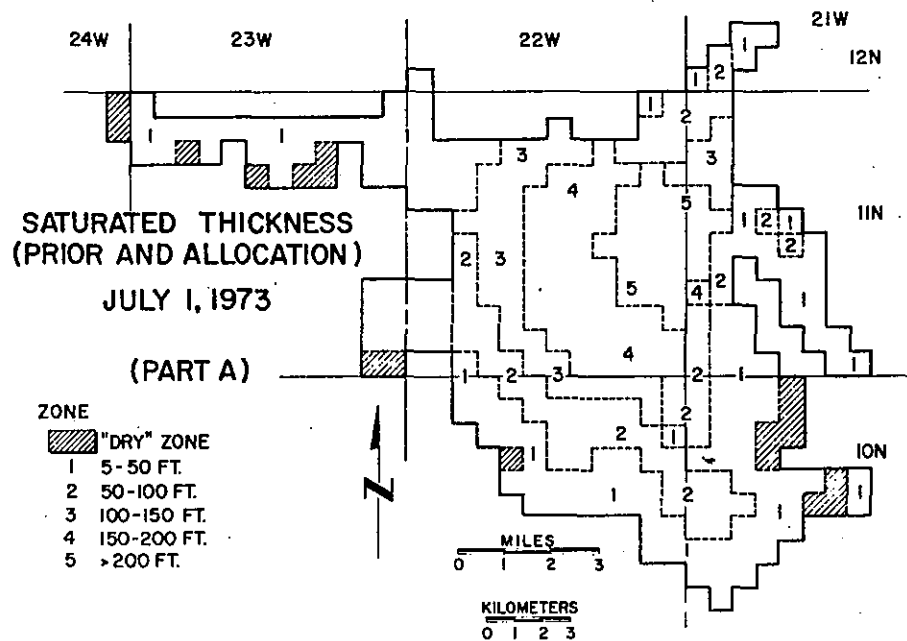

Figure 26, 1973 saturated thickness (Part A).

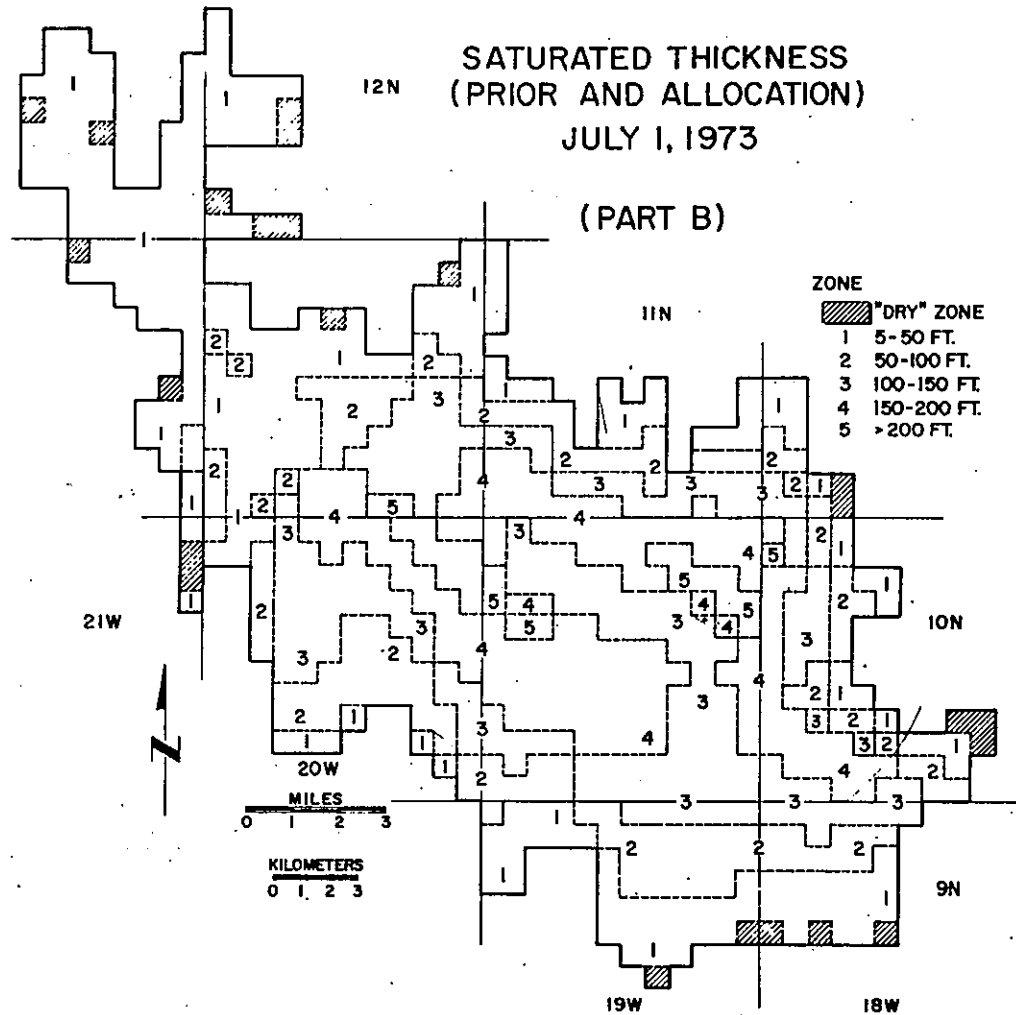

Figure 27. 1973 saturated thickness (Part B).

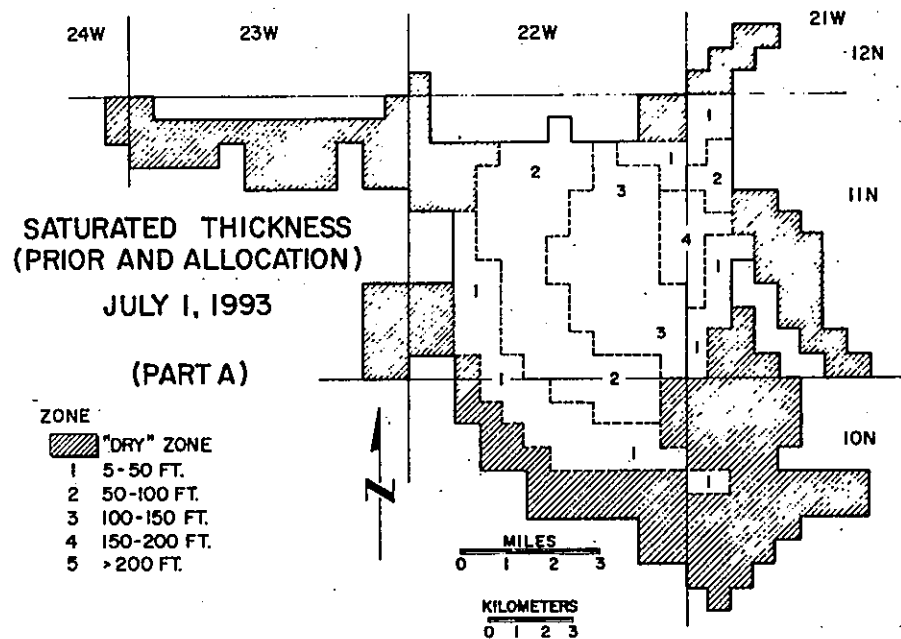

Figure 28. 1993 saturated thickness map (irrigation allocation) (Part A).

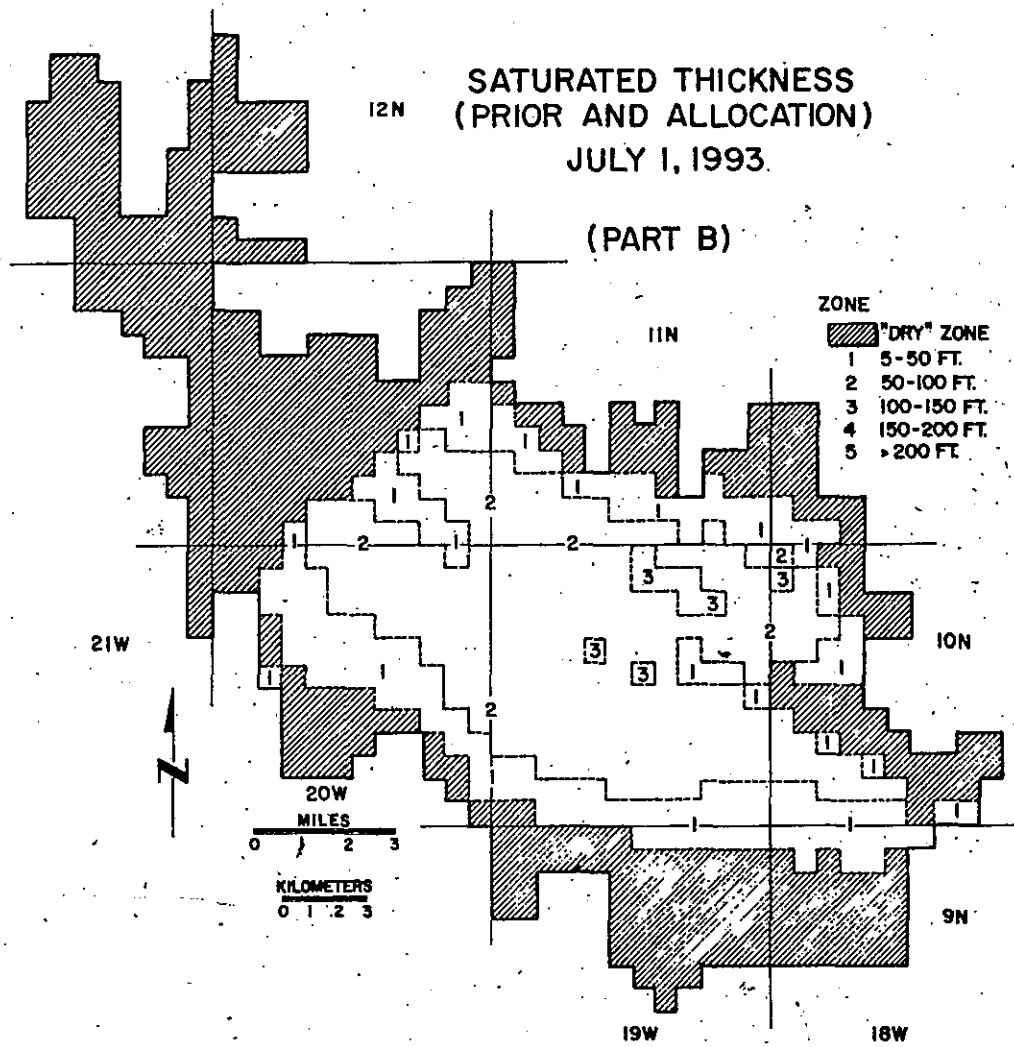

Figure 29. 1993 saturated thickness map (irrigation allocation) (Part B).

ground-water is leaving the aquifer through the streams in the area as base flow.

There should be no adverse impact on the ground-water chemistry due to partial depletion of the aquifer. The similarity between stream and ground-water quality would suggest that there will not be any significant degradation of ground-water quality due to induced recharge from streams caused by aquifer depletion.

REFERENCES CITED

- Al-Shaieb, Z. Personal interview, Stillwater, Oklahoma, December 15, 1980.
- Bredehoeft, J. D. and Pinder, G. F. 1973. Mass Transport in Flowing Ground Water: Water Resources Research. Vol. 9, No. 1, pp. 194-210.
- Griffen, W. E. 1949. Residual Gravity in Theory and Practice: Geophysics. Vol. 14, p. 39-56.
- Kent, D. C. and Naney, W. N. 1978. Results of computer modelling of alluvium and terrace deposits in western Tillman County and along the Washita River, southwestern Oklahoma for water supply capability: Final Report to Oklahoma Water Resources Board, Oklahoma State University.
- _____. 1980. Evaluation of aquifer performance and water supply capabilities of alluvial deposits of the North fork of the Red River in Beckham, Greet, Kiowa, and Jackson Counties, Oklahoma: Final Report to Oklahoma Water Resources Board, Oklahoma State University.
- Palmquist, W. N. and Koopman, F. C. 1964. Occurrence availability of groundwater in northwestern Washita County, Oklahoma: Unpublished Report for U. S. Government, p. 60.
- Pinder, G. F. 1970. An interactive digital model for aquifer evaluation: U.S. Geological Survey Open-File Report.
- Richardson, J. L. 1970. Areal geology of western Washita County, Oklahoma: Unpublished Master's thesis, University of Oklahoma, 67 p.
- Smith, A. H. 1964. Areal geology of Elk City area, Beckham, and Roger Mills Counties, Oklahoma: Unpublished Master's thesis, University of Oklahoma, 64 p.
- Trescott, P. C., Pinder, G. F., and Larson, S. P. 1976. Finite Difference Model for Aquifer Simulation in Two Dimensions with Results of Numerical Experiments: U. S. Geological Survey Techniques of Water Resources Investigations, Book 7, Chapter C1, 116 p.
- Walton, W. C. 1970. Ground-Water Resource Evaluation: New York, McGraw-Hill Book Company, 664 p.
- Witz, F. 1978. User's manual for print/plot package: Unpublished Report, Oklahoma State University.
- Zabawa, P. J. 1976. Investigation of surficial structural geology of

portions of Beckham, Custer, Roger Mills, and Washita Counties,
Oklahoma: Unpublished Master's thesis, University of Oklahoma.

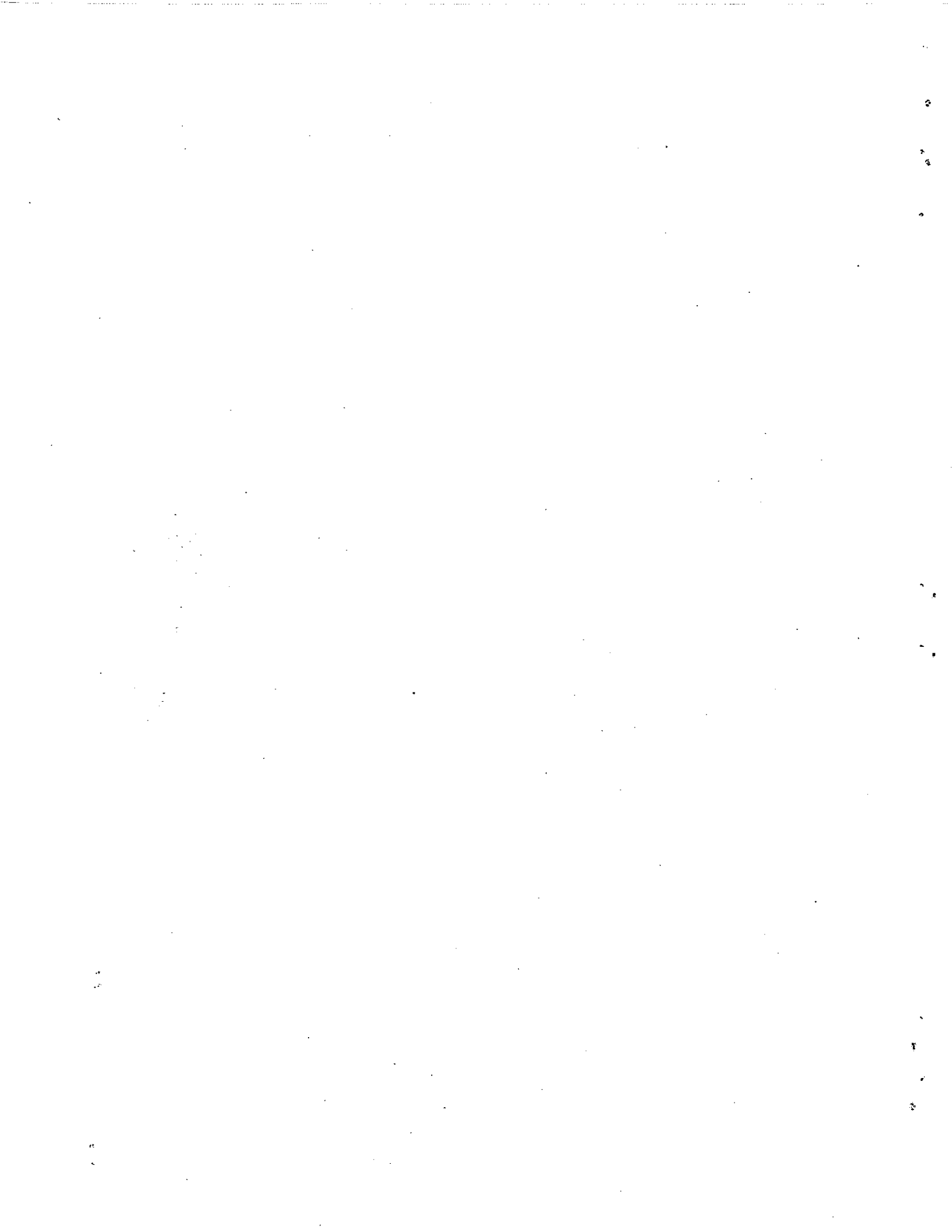

APPENDIX A
COMPUTER SIMULATION RESULTS

APPENDIX A-1
COMBINED RESULTS FOR ENTIRE AREA

	Page
Twenty-Year Ground-Water Budget.....	59
Mass Balance.....	60
Water Distribution Summary	
July 1, 1973.....	61
July 1, 1993.....	62
Area vs. Saturated Thickness	
Year 1973.....	63
Year 1993.....	64
Stored Water vs. Saturated Thickness	
Year 1973.....	65
Year 1993.....	66

TWENTY YEAR GROUND WATER BUDGET FOR ELK CITY (Entire Area)

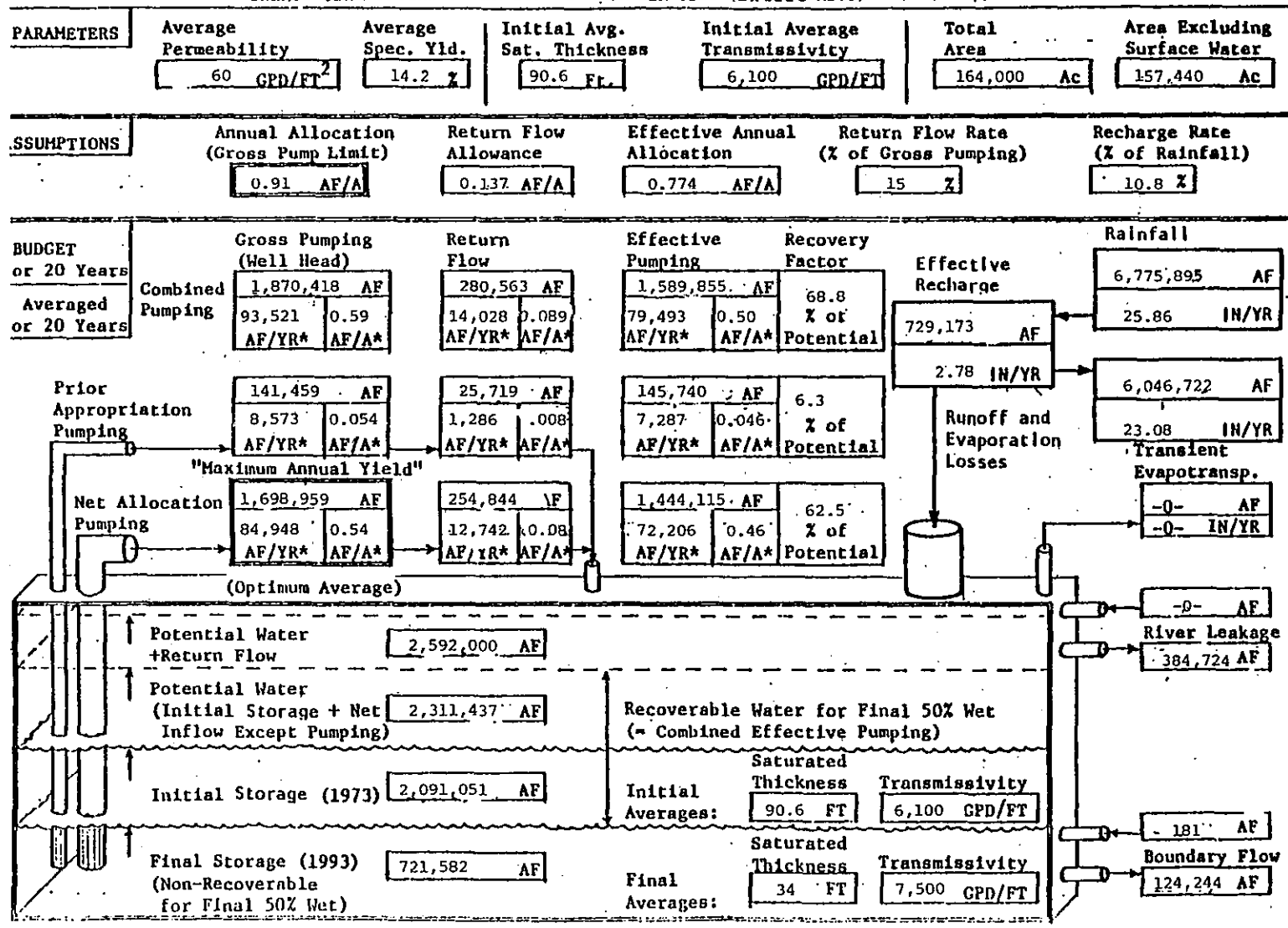

MASS BALANCE

ELK CITY (ENTIRE AREA)

Prior Appropriative and Allocation Pumping

July 1, 1973 and July 1, 1993

	Average Annual (Acre Feet)		Total (Acre Feet)	
	Inflow	Outflow	Inflow	Outflow
Recharge	+36,458		+729,173	
Pumpage		- 79,493		-1,589,855
River Leakage		- 19,236		- 384,724
Subsurface Flow	+ 9	- 6,212	+ 181	- 124,244
	-----	-----	-----	-----
TOTALS	+36,467	-104,941	+729,354	-2,098,823
Net Storage		- 68,747		-1,369,469

WATER DISTRIBUTION SUMMARY
ELK CITY ENTIRE AREA
July 1, 1973

SATURATED THICKNESS RANGE (FEET)	AREA (% OF TOTAL)	AREA (ACRES)	AVERAGE SATURATED THICKNESS (FEET)	AVERAGE SPECIFIC YIELD (%)	STORED WATER (AC.FT.)
5.50- 10.00	0.7	1,120	7.8	13.6	1,196
10.00- 15.00	6.1	9,600	10.5	13.6	13,757
15.00- 20.00	4.1	6,400	15.8	13.6	13,824
20.00- 30.00	8.2	12,960	23.6	13.6	41,779
30.00- 40.00	9.5	14,880	33.8	13.6	68,536
40.00- 50.00	7.5	11,840	43.7	13.6	70,586
50.00- 60.00	7.0	11,040	52.9	13.6	79,634
60.00- 70.00	4.5	7,040	63.9	13.6	61,415
70.00- 80.00	3.8	5,920	73.7	13.6	59,520
80.00- 90.00	4.0	6,240	85.1	13.7	72,496
90.00-100.00	2.2	3,520	93.7	13.7	45,067
100.00-110.00	3.5	5,440	104.9	13.6	77,846
110.00-120.00	2.7	4,320	114.9	14.7	72,803
120.00-130.00	3.8	5,920	125.1	13.7	101,248
130.00-140.00	5.2	8,160	135.4	14.5	160,296
140.00-150.00	4.7	7,360	145.0	15.3	163,552
150.00-160.00	5.8	7,520	154.9	15.0	174,984
160.00-170.00	4.0	6,240	165.1	15.0	154,303
170.00-180.00	3.6	5,600	174.4	14.8	145,012
180.00-190.00	2.5	4,000	184.7	15.8	116,706
190.00-200.00	2.8	4,480	196.0	16.7	146,518
200.00-210.00	3.7	5,760	204.8	15.9	187,596
210.00-220.00	0.9	1,440	213.8	13.7	42,285
220.00-230.00	0.3	480	226.6	13.6	14,840
230.00-240.00	0.0	0	0.0	0.0	0
240.00-250.00	0.1	160	240.2	13.6	5,243
	---	-----			-----
ALL RANGES	100.0 (TOTAL)	157,440 (TOTAL)	90.6 (AVERAGE)	14.7 (AVERAGE)	2,091,051 (TOTAL)

WATER DISTRIBUTION SUMMARY
ELK CITY ENTIRE AREA
JULY 1, 1993

SATURATED THICKNESS RANGE (FEET)	AREA (% OF TOTAL)	AREA (ACRES)	AVERAGE SATURATED THICKNESS (FEET)	AVERAGE SPECIFIC YIELD (%)	STORED WATER (AC.FT.)
0.00- 5.50	47.9	75,360	4.8	13.6	49,862
5.50- 10.00	2.0	3,200	7.4	13.6	3,218
10.00- 15.00	2.6	4,160	12.2	13.6	6,916
15.00- 20.00	2.3	3,680	17.3	13.7	8,682
20.00- 30.00	4.0	6,240	24.4	13.7	20,805
30.00- 40.00	5.0	7,840	34.7	14.0	38,255
40.00- 50.00	5.1	8,000	44.7	14.2	50,966
50.00- 60.00	5.6	8,800	54.5	14.7	70,316
60.00- 70.00	5.7	8,960	64.4	14.6	84,488
70.00- 80.00	4.5	7,040	74.9	14.4	76,032
80.00- 90.00	4.3	6,720	85.0	15.3	87,348
90.00-100.00	5.3	8,320	94.6	17.1	134,616
100.00-110.00	1.7	2,720	103.8	16.1	45,455
110.00-120.00	1.1	1,760	114.1	15.4	30,936
120.00-130.00	1.1	1,760	125.9	15.7	34,831
130.00-140.00	0.7	1,120	133.1	13.9	20,718
140.00-150.00	0.1	160	142.3	13.6	3,107
150.00-160.00	0.2	320	158.8	13.6	6,933
160.00-170.00	0.4	640	164.4	13.6	14,356
170.00-180.00	0.3	480	175.8	13.6	11,514
180.00-190.00	0.1	160	182.0	13.6	3,973
ALL RANGES	100.0 (TOTAL)	157,440 (TOTAL)	34.1 (AVERAGE)	14.9 (AVERAGE)	803,335 (TOTAL)

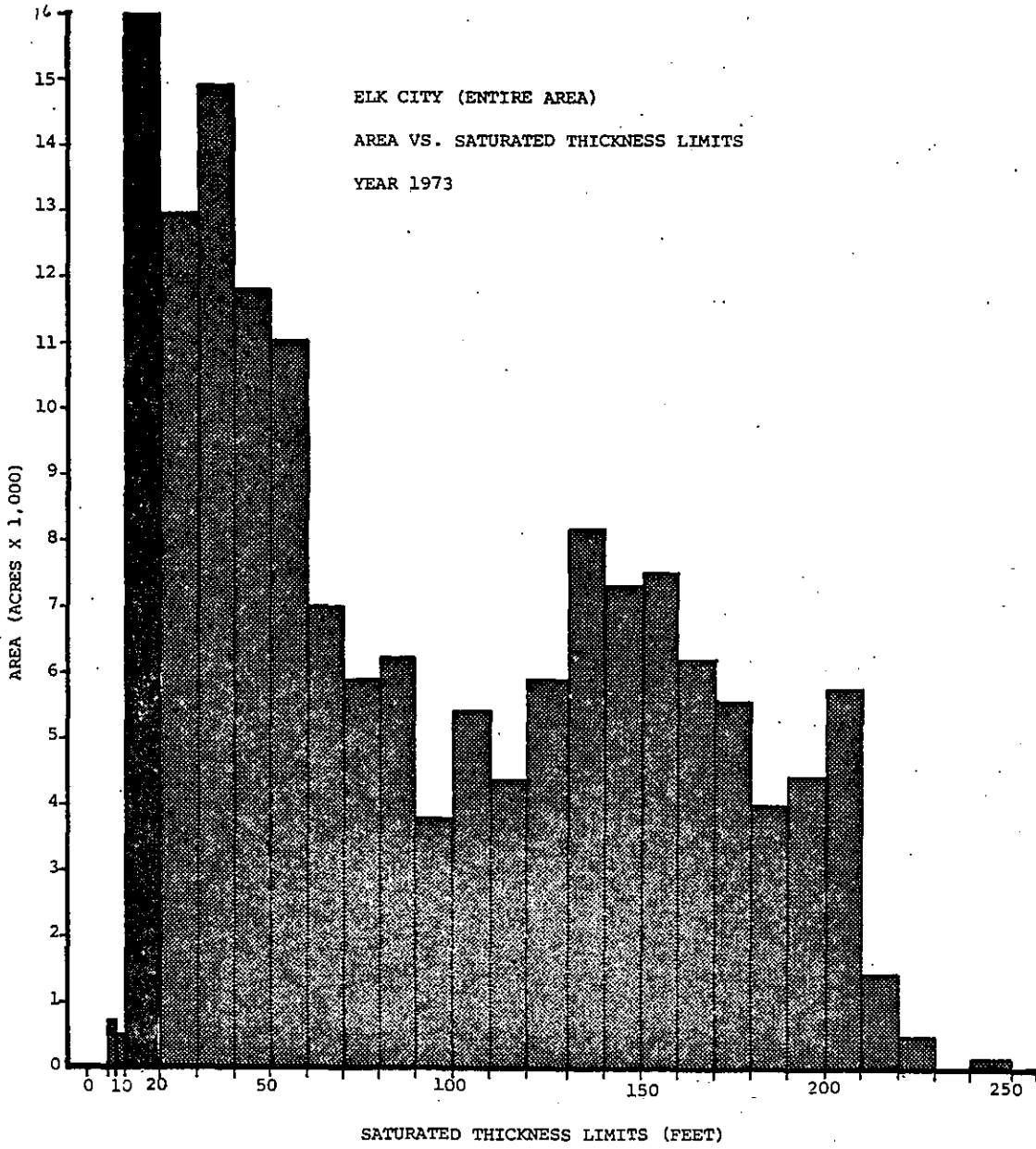

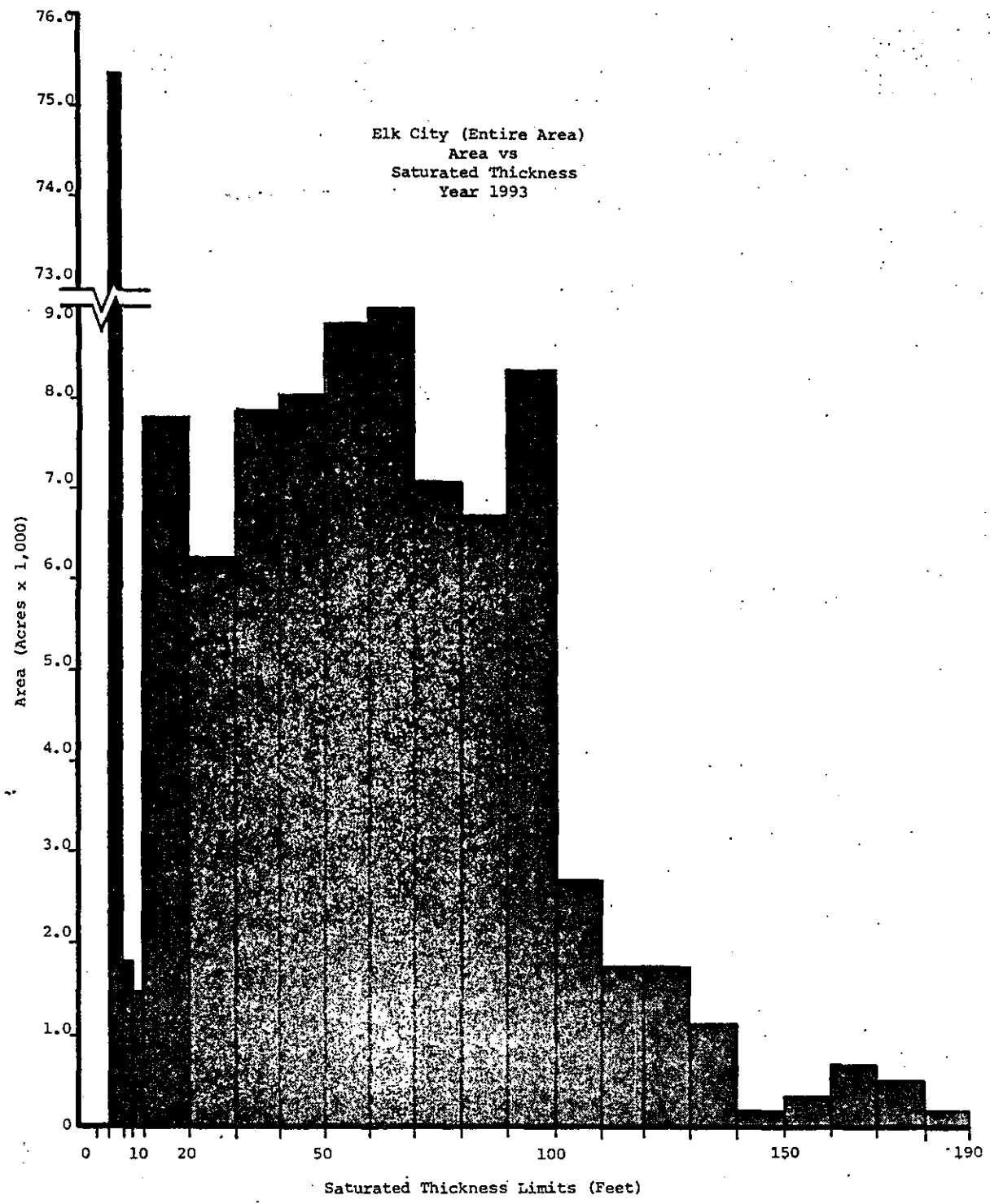

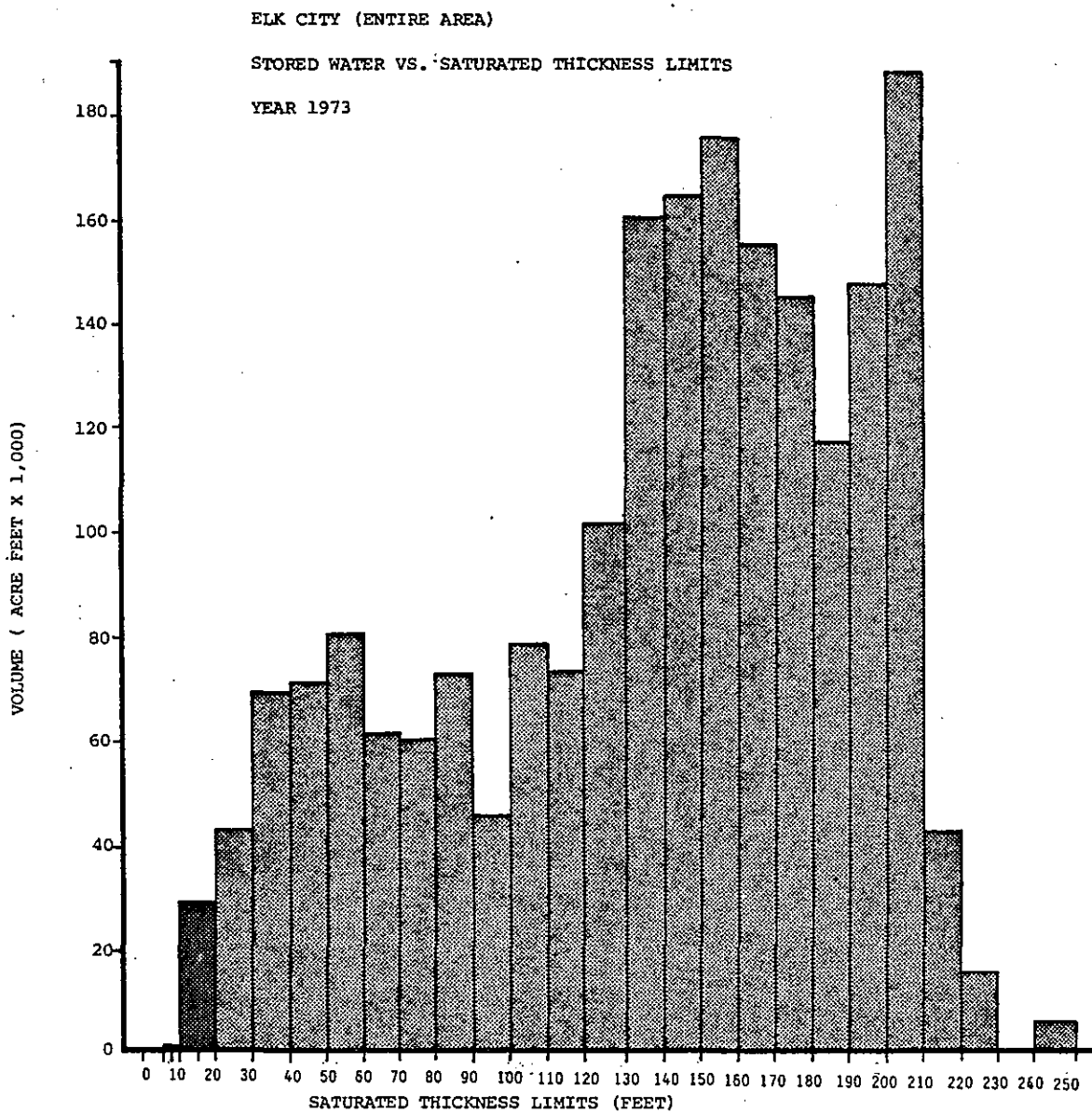

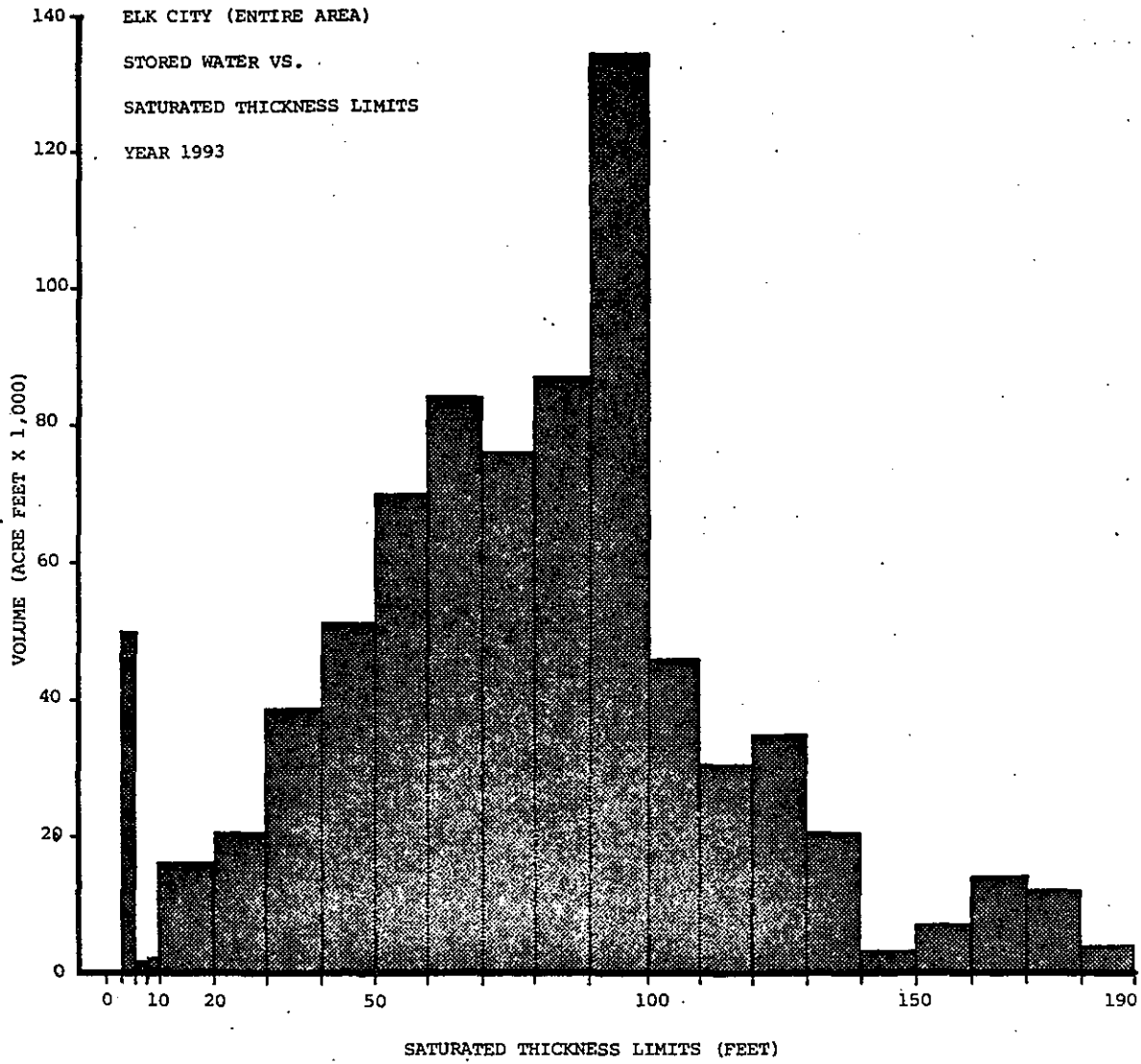

APPENDIX A-2

RESULTS FOR ELK CITY PART A

	Page
Twenty-Year Ground-Water Budget.....	68
Mass Balance.....	69
Water Distribution Summary	
July 1, 1973.....	70
July 1, 1993.....	71
Area vs. Saturated Thickness Limits	
Year 1973.....	72
Year 1993.....	73
Stored Water vs Saturated Thickness	
Year 1973.....	74
Year 1993.....	75
Saturated Thickness Maps	
Year 1978.....	76
Year 1983.....	77
Year 1988.....	78
Transmissivity, July 1, 1993.....	79
Water Depth	
July 1, 1973.....	80
July 1, 1993.....	81

TWENTY YEAR GROUND WATER BUDGET - ELK CITY - A

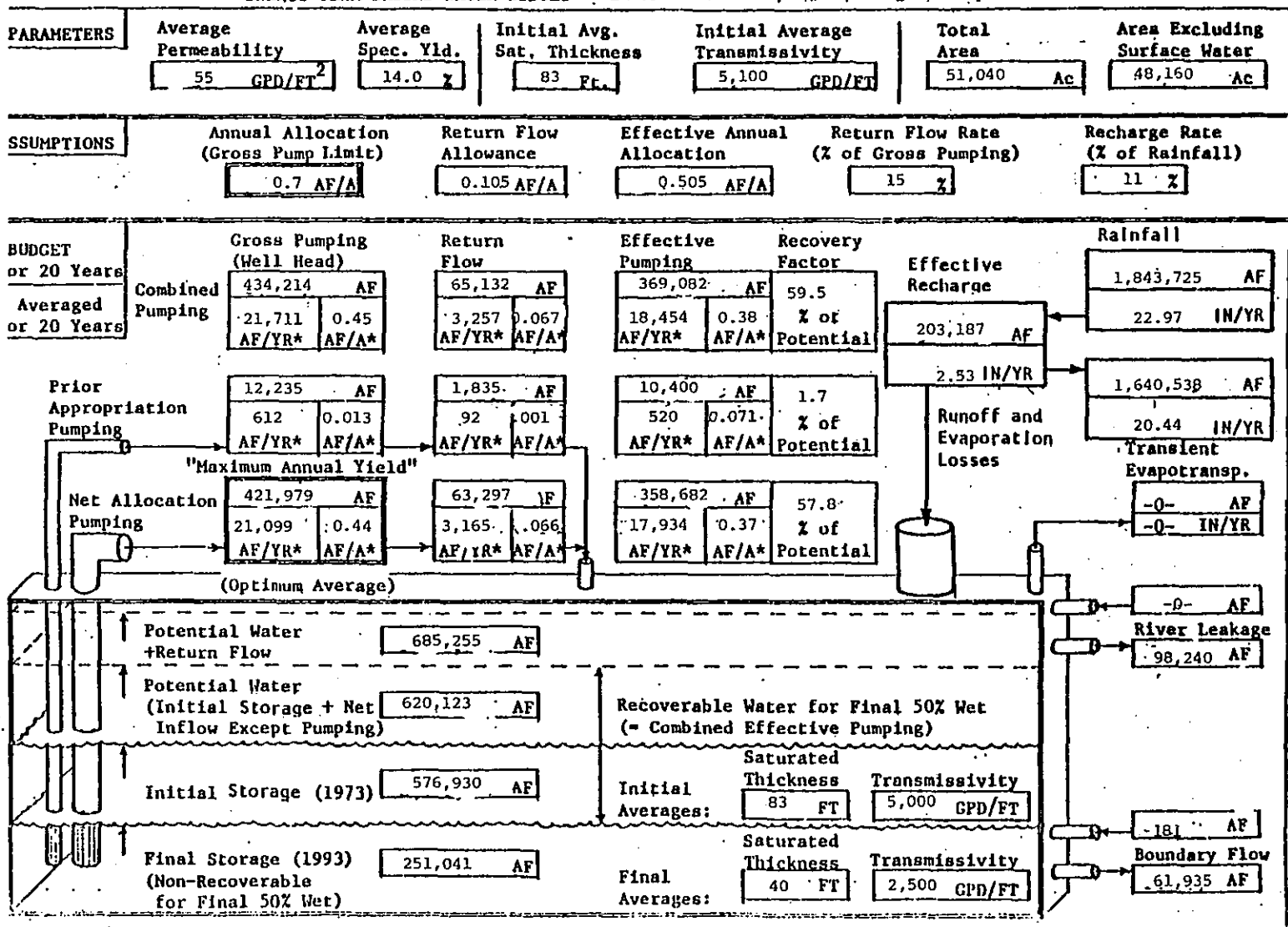

MASS BALANCE OF PRIOR AND ALLOCATION PUMPING
FROM JULY 1, 1973 TO JULY 1, 1993
(PART-A)

	Average Annual (Acre Feet)		Twenty-Year Total (Acre Feet)	
	Inflow	Outflow	Inflow	Outflow
Recharge	+10,159		+203,187	
Pumpage		-18,454		-369,082
River Leakeae		- 4,912		- 98,240
Subsurface Flow	+ 9	- 3,097	+ 181	- 61,935
	-----	-----	-----	-----
TOTALS	+10,168	-26,463	+203,368	-529,257
Net Storage Change		-16,295		-325,889

WATER DISTRIBUTION SUMMARY
ELK CITY PART A
JULY 1, 1973

SATURATED THICKNESS RANGE (FEET)	AREA (% OF TOTAL)	AREA (ACRES)	AVERAGE SATURATED THICKNESS (FEET)	AVERAGE SPECIFIC YIELD (%)	STORED WATER (AC.FT.)
5.50- 10.00	0.3	160	7.1	13.6	154
10.00- 15.00	10.6	5,120	10.4	13.6	7,295
15.00- 20.00	5.6	2,720	15.8	13.6	5,053
20.00- 30.00	8.6	4,160	23.4	13.6	13,277
30.00- 40.00	9.3	4,480	34.6	13.6	21,130
40.00- 50.00	9.3	4,480	43.9	13.6	26,815
50.00- 60.00	8.3	4,000	53.3	13.6	29,082
60.00- 70.00	4.0	1,920	63.1	13.6	16,521
70.00- 80.00	5.0	2,400	74.9	13.7	24,543
80.00- 90.00	3.7	1,760	86.5	13.7	20,015
90.00-100.00	1.0	480	93.7	13.8	6,200
100.00-110.00	2.3	1,120	106.5	13.6	16,273
110.00-120.00	2.0	960	114.7	13.9	15,317
120.00-130.00	2.0	960	123.1	13.8	16,306
130.00-140.00	4.0	1,920	135.8	14.1	36,842
140.00-150.00	2.3	1,120	145.2	14.8	24,027
150.00-160.00	3.0	1,440	156.6	15.6	35,271
160.00-170.00	2.7	1,280	166.2	15.9	33,744
170.00-180.00	2.3	1,120	175.1	16.0	31,324
180.00-190.00	3.0	1,440	184.8	15.5	41,286
190.00-200.00	2.3	1,120	194.7	15.7	34,229
200.00-210.00	4.0	1,920	204.4	14.8	58,255
210.00-220.00	3.0	1,440	213.8	13.7	42,285
220.00-230.00	1.0	480	226.6	13.6	14,840
230.00-240.00	0.0	0	0.0	0.0	0
240.00-250.00	0.3	160	240.2	13.6	5,243
	-----	-----			-----
ALL RANGES	100.0	48,160	82.9	14.4	576,930
	(TOTAL)	(TOTAL)	(AVERAGE)	(AVERAGE)	(TOTAL)

WATER DISTRIBUTION SUMMARY
ELK CITY PART A
JULY 1, 1993

SATURATED THICKNESS RANGE (FEET)	AREA (% OF TOTAL)	AREA (ACRES)	AVERAGE SATURATED THICKNESS (FEET)	AVERAGE SPECIFIC YIELD (%)	STORED WATER (AC.FT.)
0.00- 5.50	50.8	24,480	4.9	13.6	16,238
5.50- 10.00	2.0	960	7.8	13.7	1,029
10.00- 15.00	2.7	1,280	13.4	13.7	2,347
15.00- 20.00	2.3	1,120	17.5	13.7	2,686
20.00- 30.00	3.0	1,440	24.5	13.7	4,823
30.00- 40.00	3.3	1,600	34.0	13.8	7,484
40.00- 50.00	3.3	1,600	45.8	13.6	10,005
50.00- 60.00	2.0	960	56.0	13.6	7,341
60.00- 70.00	4.0	1,920	65.9	13.8	17,496
70.00- 80.00	4.3	2,080	74.5	14.6	22,690
80.00- 90.00	3.3	1,600	85.7	15.3	21,042
90.00-100.00	3.3	1,600	95.1	15.8	24,108
100.00-110.00	2.7	1,280	104.7	15.6	20,873
110.00-120.00	3.3	1,600	114.5	15.6	28,530
120.00-130.00	3.7	1,760	125.9	15.7	34,831
130.00-140.00	2.3	1,120	133.1	13.9	20,718
140.00-150.00	0.3	160	142.3	13.6	3,107
150.00-160.00	0.7	320	158.8	13.6	6,933
160.00-170.00	1.3	640	164.4	13.6	14,356
170.00-180.00	1.0	480	175.8	13.6	11,514
180.00-190.00	0.3	160	182.0	13.6	3,973
	----	-----			-----
ALL RANGES	100.0 (TOTAL)	48,160 (TOTAL)	40.1 (AVERAGE)	14.6 (AVERAGE)	282,135 (TOTAL)

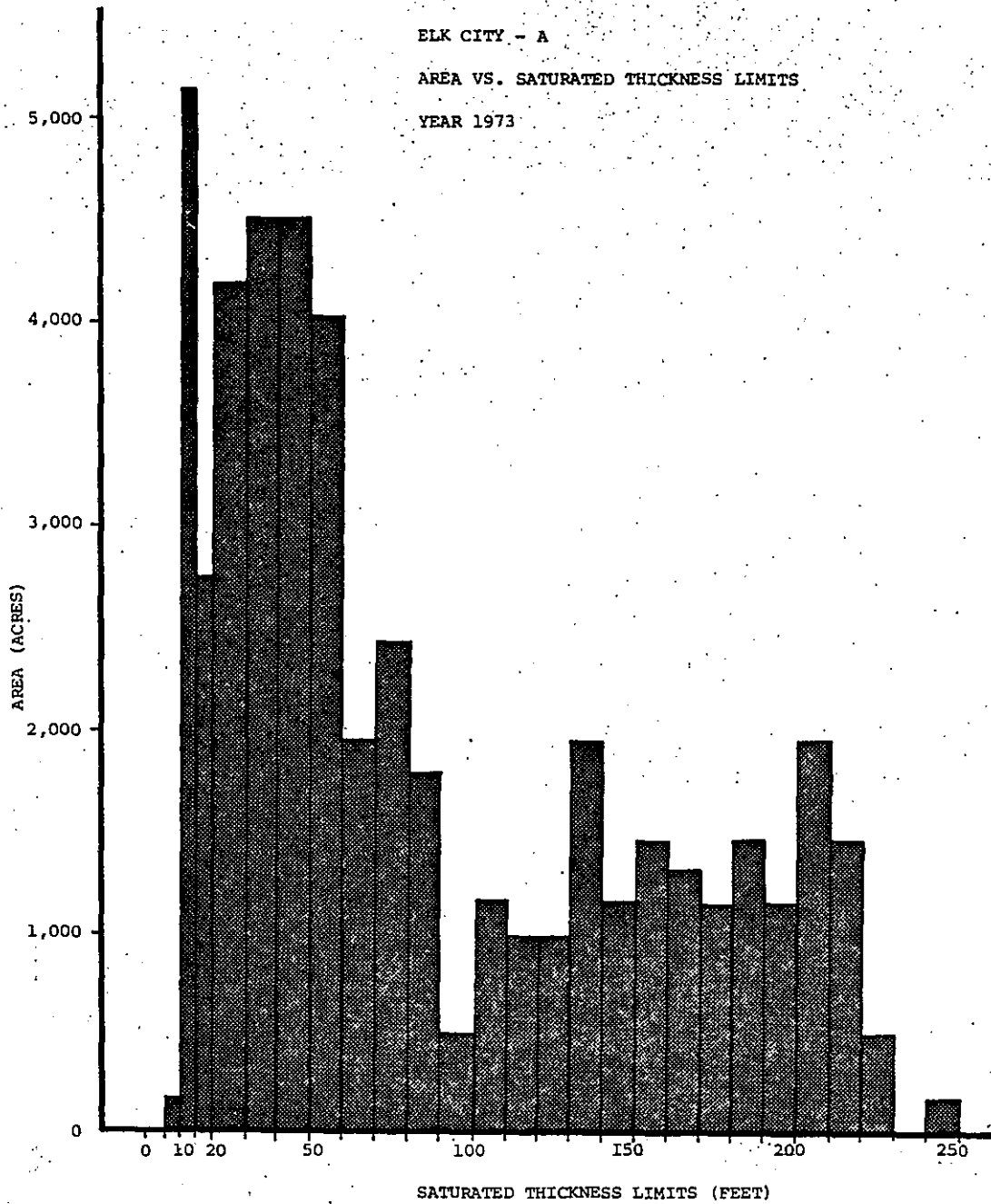

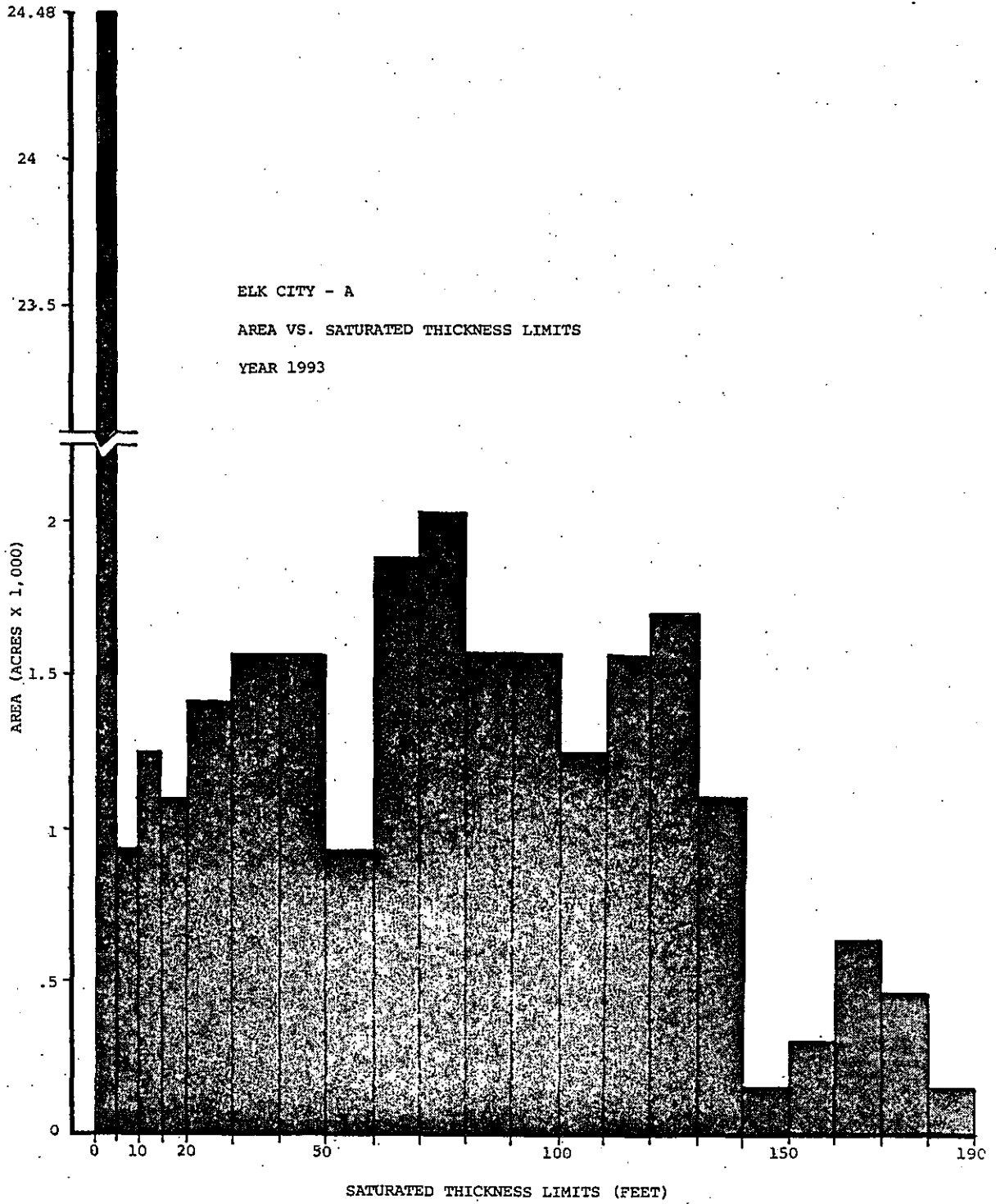



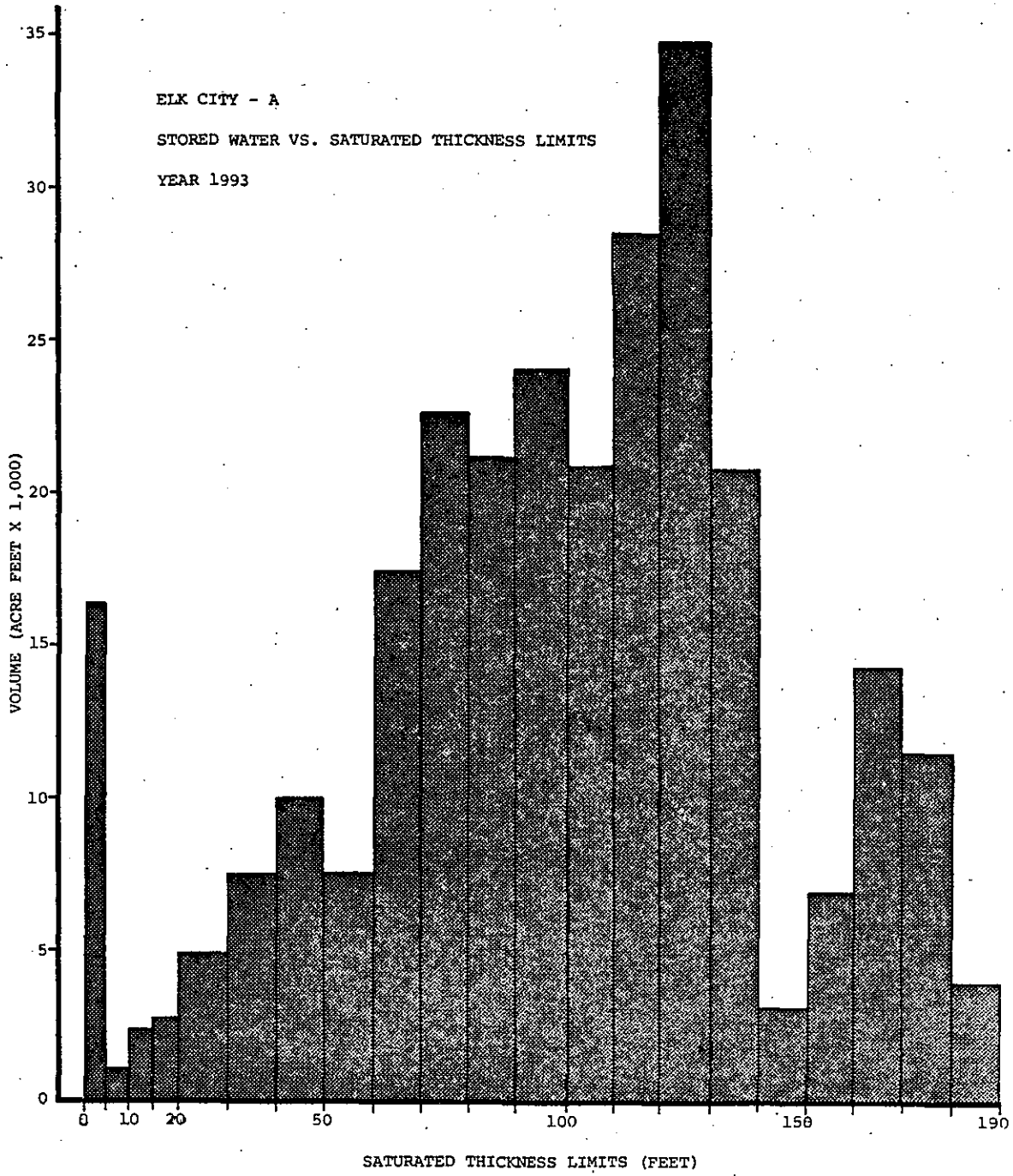

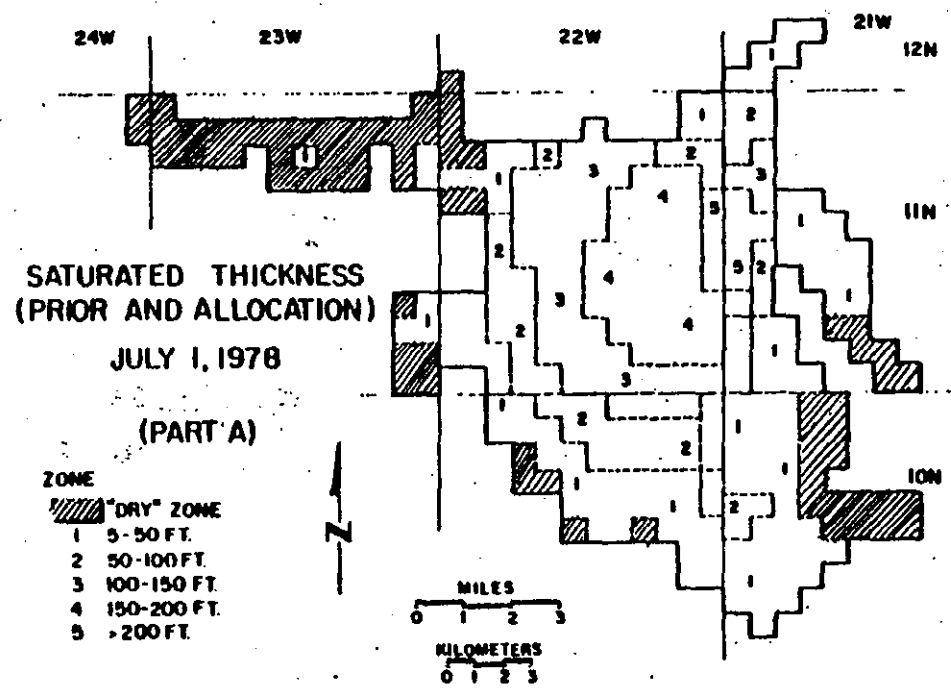

**SATURATED THICKNESS
(PRIOR AND ALLOCATION)**

JULY 1, 1978

(PART A)

- ZONE**
-  "DRY" ZONE
 - 1 5-50 FT.
 - 2 50-100 FT.
 - 3 100-150 FT.
 - 4 150-200 FT.
 - 5 >200 FT.

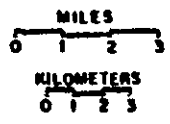

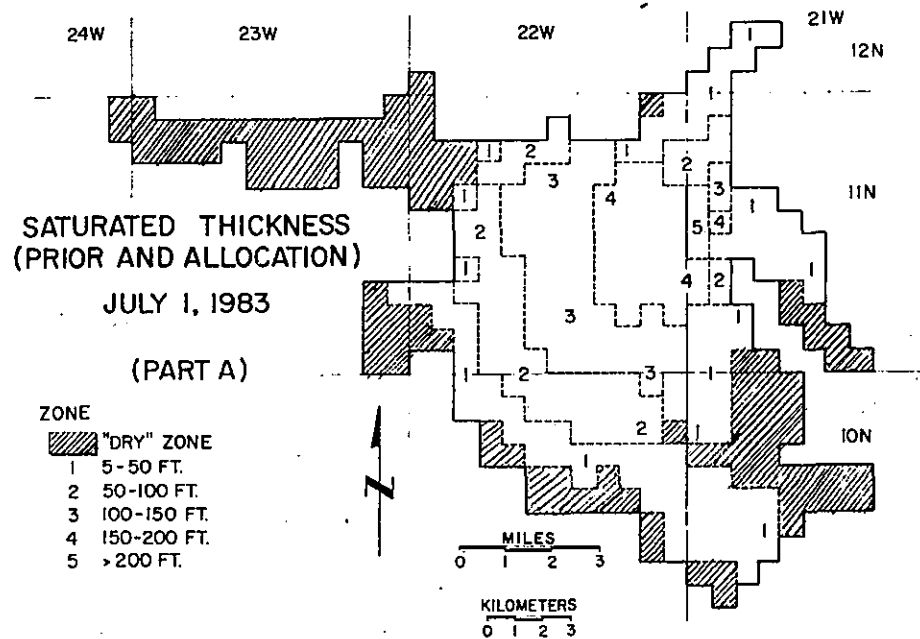

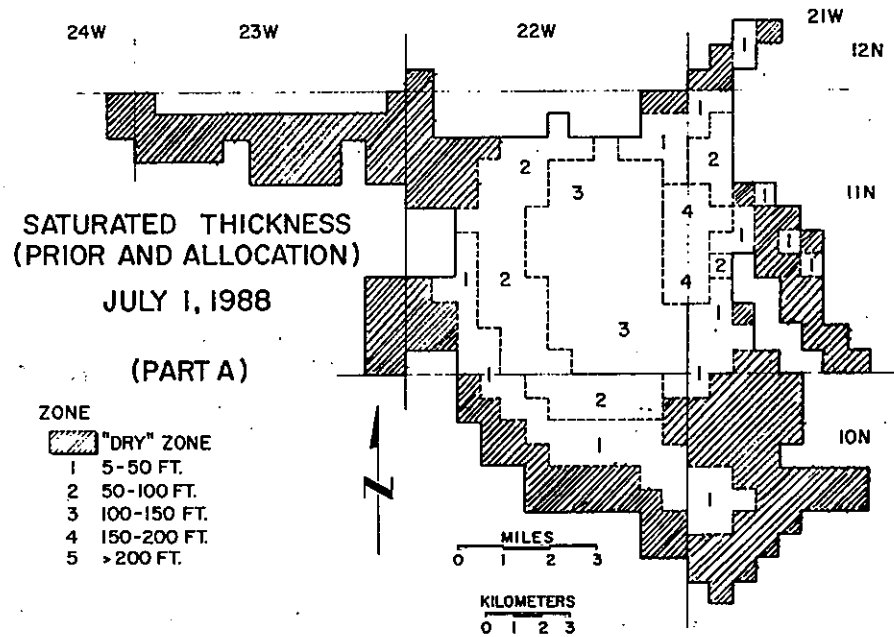

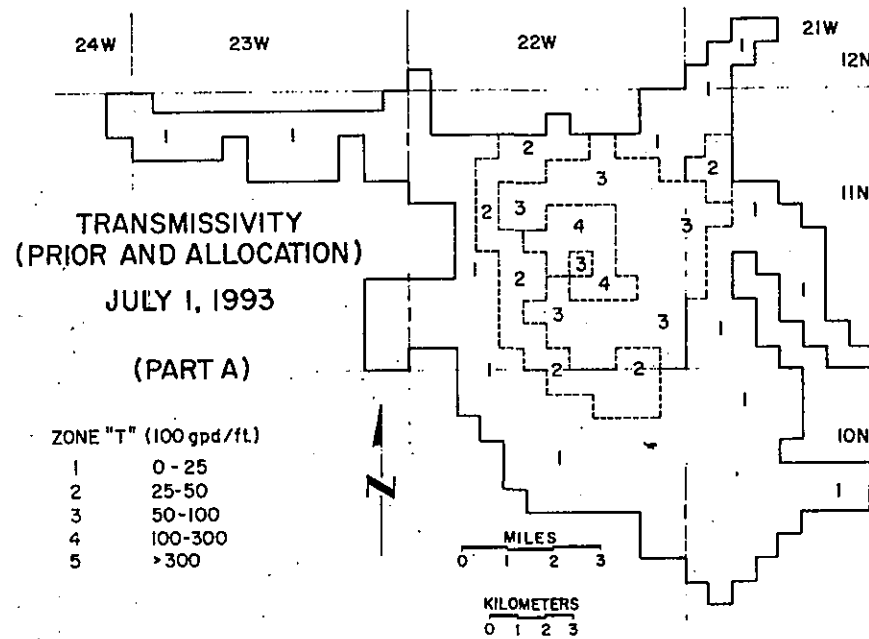

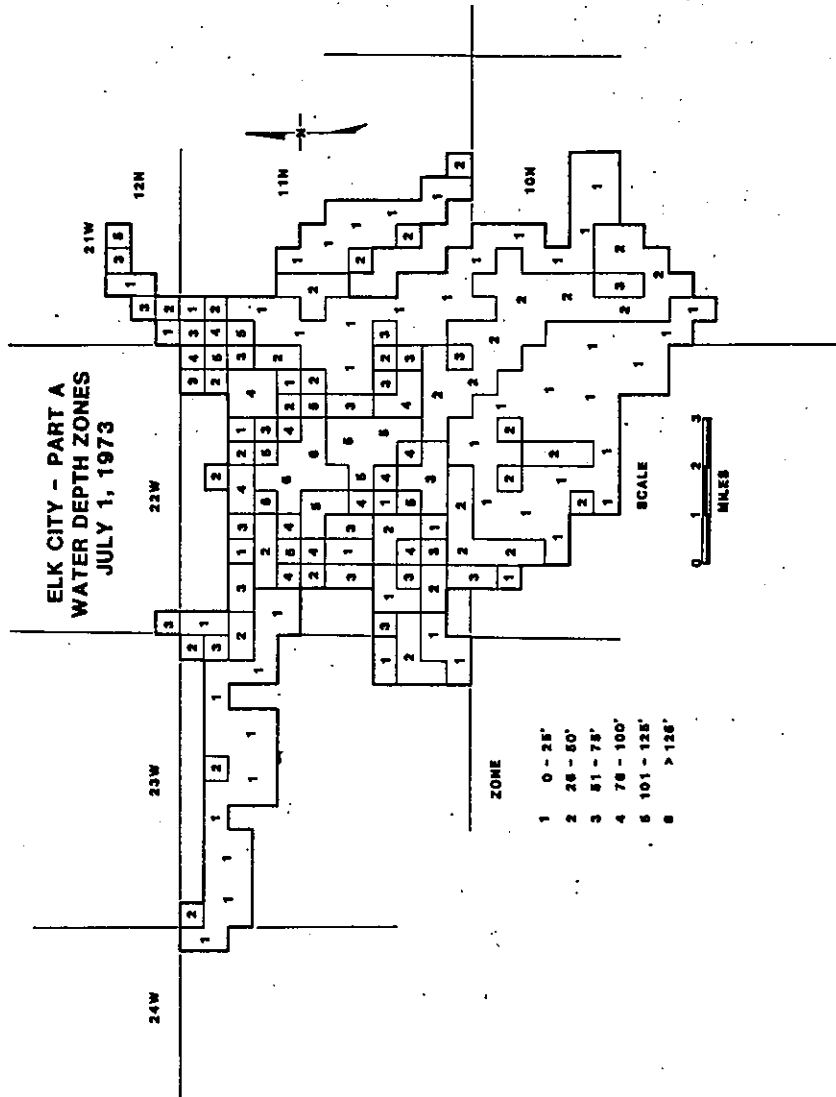

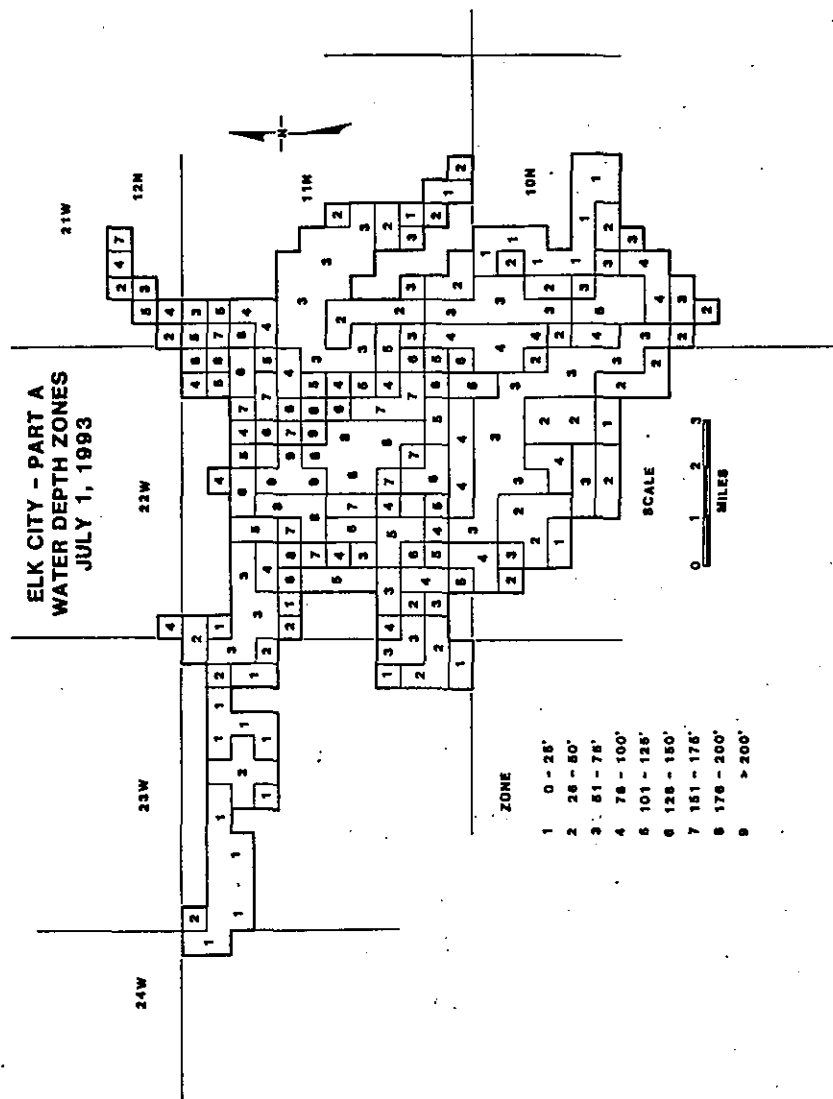

APPENDIX A-3

RESULTS FOR ELK CITY PART B

	Page
Twenty-Year Ground-Water Budget.....	83
Mass Balance.....	84
Water Distribution Summary	
July 1, 1973.....	85
July 1, 1993.....	86
Area vs. Saturated Thickness	
Year 1973.....	87
Year 1993.....	88
Stored Water vs. Saturated Thickness	
Year 1973.....	89
Year 1993.....	90
Saturated Thickness Maps	
Year 1978.....	91
Year 1983.....	92
Year 1988.....	93
Transmissivity, July 1, 1993.....	94
Water Depth	
July 1, 1973.....	95
July 1, 1993.....	96

TWENTY YEAR GROUND WATER BUDGET ELK CITY - B

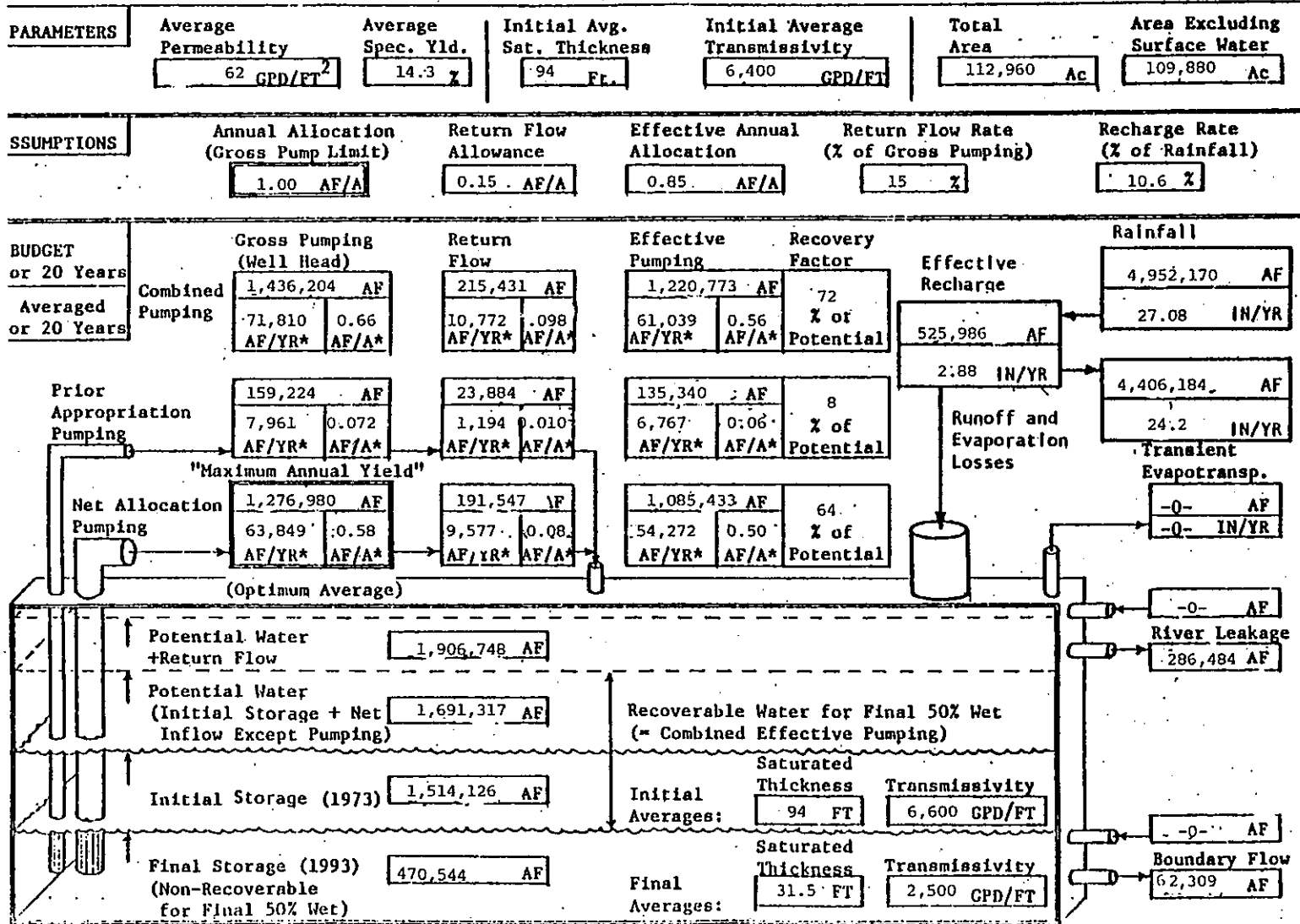

MASS BALANCE OF PRIOR AND ALLOCATION PUMPING
FROM JULY 1, 1973 TO JULY 1, 1993
(PART-B)

	Average Annual (Acre Feet)		Twenty-Year Total (Acre Feet)	
	Inflow	Outflow	Inflow	Outflow
Recharge	+26,299		+525,986	
Pumpage		-61,039		-1,220,773
River Leakage		-14,324		- 286,484
Subsurface Flow		- 3,115		- 62,309
	-----	-----	-----	-----
TOTALS	+26,299	-78,478	+525,986	-1,569,566
Net Storage Change		-52,179		-1,043,580

WATER DISTRIBUTION SUMMARY

ELK CITY PART B

JULY 1, 1973

85

SATURATED THICKNESS RANGE (FEET)	AREA (% OF TOTAL)	AREA (ACRES)	AVERAGE SATURATED THICKNESS (FEET)	AVERAGE SPECIFIC YIELD (%)	STORED WATER (AC.FT.)
5.50- 7.50	0.4	480	7.1	13.6	467
7.50- 10.00	0.4	480	8.8	13.6	573
10.00- 15.00	4.1	4,480	10.6	13.6	6,471
15.00- 20.00	3.4	3,680	15.9	13.6	7,971
20.00- 25.00	4.4	4,800	20.8	13.6	13,608
25.00- 30.00	3.7	4,000	27.3	13.6	14,893
30.00- 35.00	5.7	6,240	31.4	13.6	26,706
35.00- 40.00	3.8	4,160	36.5	13.6	20,700
40.00- 45.00	3.8	4,160	41.4	13.6	23,480
45.00- 50.00	2.9	3,200	46.5	13.6	20,290
50.00- 55.00	4.5	4,960	51.1	13.6	34,568
55.00- 60.00	1.9	2,080	56.3	13.6	15,985
60.00- 65.00	2.2	2,400	61.4	13.6	20,093
65.00- 70.00	2.5	2,720	66.8	13.6	24,800
70.00- 75.00	1.9	2,080	71.0	13.6	20,155
75.00- 80.00	1.3	1,440	75.4	13.6	14,821
80.00- 85.00	1.9	2,080	82.2	13.6	23,323
85.00- 90.00	2.2	2,400	86.6	13.6	28,358
90.00- 95.00	1.6	1,760	91.2	13.6	21,897
95.00-100.00	1.2	1,280	97.2	13.6	16,969
100.00-105.00	1.9	2,080	101.8	13.6	28,906
105.00-110.00	2.0	2,240	106.9	13.6	32,666
110.00-115.00	1.2	1,280	111.4	14.5	20,641
115.00-120.00	1.9	2,080	117.1	15.1	36,844
120.00-125.00	1.8	1,920	120.0	13.6	31,975
125.00-130.00	2.8	3,040	127.7	13.6	52,967
130.00-135.00	1.9	2,080	132.2	14.6	40,022
135.00-140.00	3.8	4,160	136.8	14.7	83,431
140.00-145.00	3.4	3,680	142.5	15.5	81,242
145.00-150.00	2.3	2,560	148.4	15.3	58,282
150.00-155.00	2.9	3,200	152.0	14.8	71,733
155.00-160.00	2.6	2,880	157.4	15.0	67,979
160.00-165.00	2.6	2,880	162.5	15.0	70,408
165.00-170.00	1.9	2,080	167.9	14.4	50,151
170.00-175.00	2.5	2,720	172.1	14.3	67,062
175.00-180.00	1.6	1,760	177.5	14.9	46,626
180.00-185.00	1.3	1,440	182.1	15.2	39,930
185.00-190.00	1.0	1,120	187.9	16.9	35,490
190.00-195.00	1.2	1,280	192.0	17.3	42,485
195.00-200.00	1.9	2,080	199.1	16.9	69,803
200.00-209.92	3.5	3,840	205.0	16.4	129,340
ALL RANGES	100.0 (TOTAL)	109,280 (TOTAL)	94.0 (AVERAGE)	14.7 (AVERAGE)	1,514,125 (TOTAL)

WATER DISTRIBUTION SUMMARY
ELK CITY PART B
JULY 1, 1993

SATURATED THICKNESS RANGE (FEET)	AREA (% OF TOTAL)	AREA (ACRES)	AVERAGE SATURATED THICKNESS (FEET)	AVERAGE SPECIFIC YIELD (%)	STORED WATER (AC.FT.)
2.50- 5.50	46.6	50,880	4.8	13.6	33,625
5.50- 7.50	1.3	1,440	6.2	13.6	1,223
7.50- 10.00	0.7	800	8.8	13.6	965
10.00- 15.00	2.6	2,880	11.6	13.6	4,568
15.00- 20.00	2.3	2,560	17.2	13.6	5,996
20.00- 25.00	2.5	2,720	22.1	13.6	8,209
25.00- 30.00	1.9	2,080	27.4	13.6	7,772
30.00- 35.00	2.9	3,200	32.6	14.4	15,065
35.00- 40.00	2.8	3,040	37.4	13.8	15,704
40.00- 45.00	3.5	3,840	42.1	13.6	22,083
45.00- 50.00	2.3	2,560	47.9	15.4	18,877
50.00- 55.00	4.2	4,640	52.3	14.6	35,534
55.00- 60.00	2.9	3,200	47.2	15.0	27,440
60.00- 65.00	4.2	4,640	62.0	15.2	43,805
65.00- 70.00	2.2	2,400	67.7	14.3	23,187
70.00- 75.00	2.3	2,560	72.4	13.9	25,670
75.00- 80.00	2.2	2,400	77.9	14.8	27,671
80.00- 85.00	2.6	2,880	82.8	15.2	36,285
85.00- 90.00	2.0	2,240	87.4	15.3	30,021
90.00- 95.00	3.2	3,520	92.2	16.9	54,707
95.00-100.00	2.9	3,200	97.0	18.0	55,801
100.00-105.00	1.0	1,120	102.0	17.2	19,666
105.00-110.00	0.3	320	106.7	14.4	4,915
110.00-115.00	0.1	160	110.2	13.6	2,405
	-----	-----			-----
ALL RANGES	100.0	109,280	31.5	15.1	521,205
	(TOTAL)	(TOTAL)	(AVERAGE)	(AVERAGE)	(TOTAL)

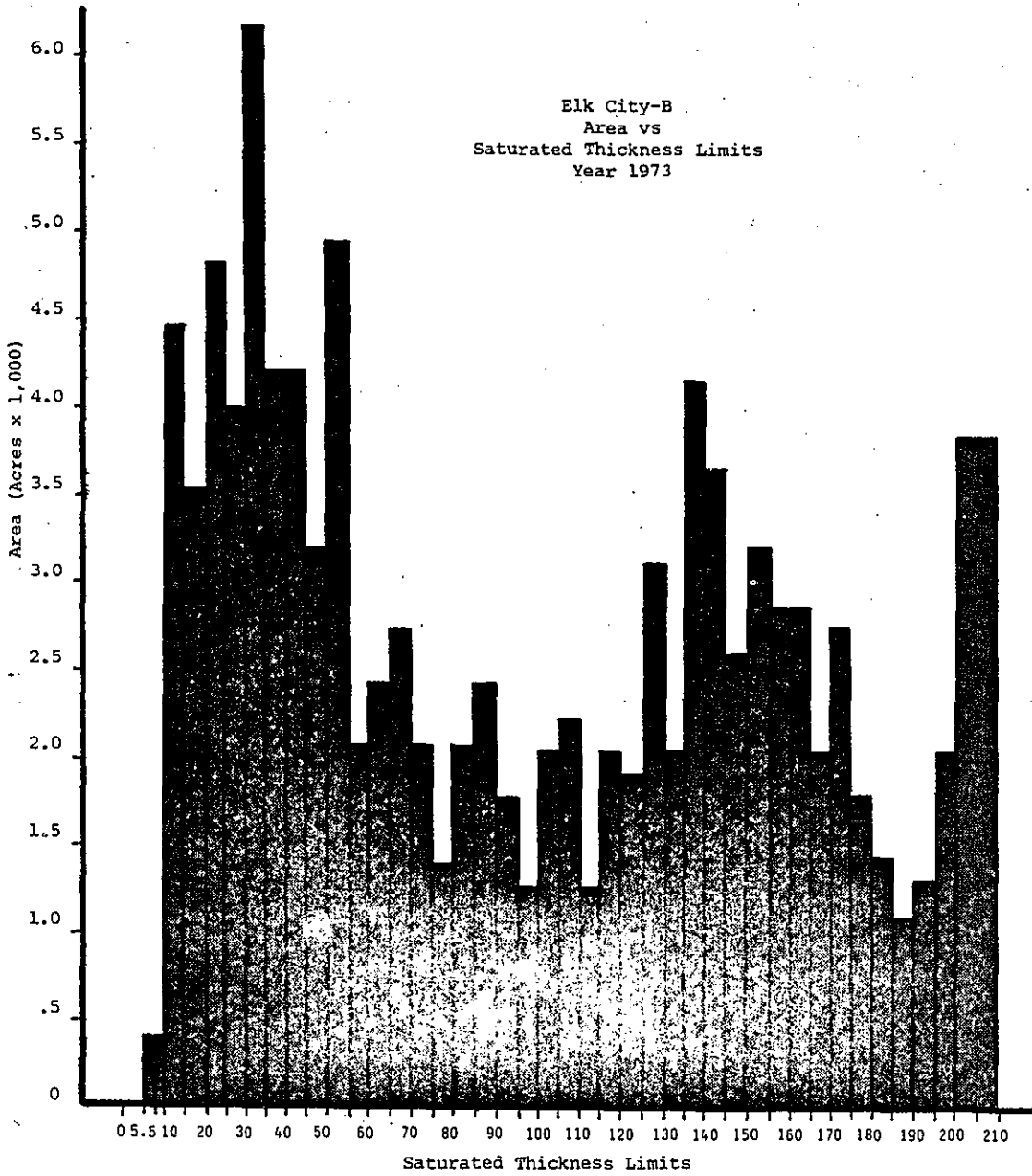

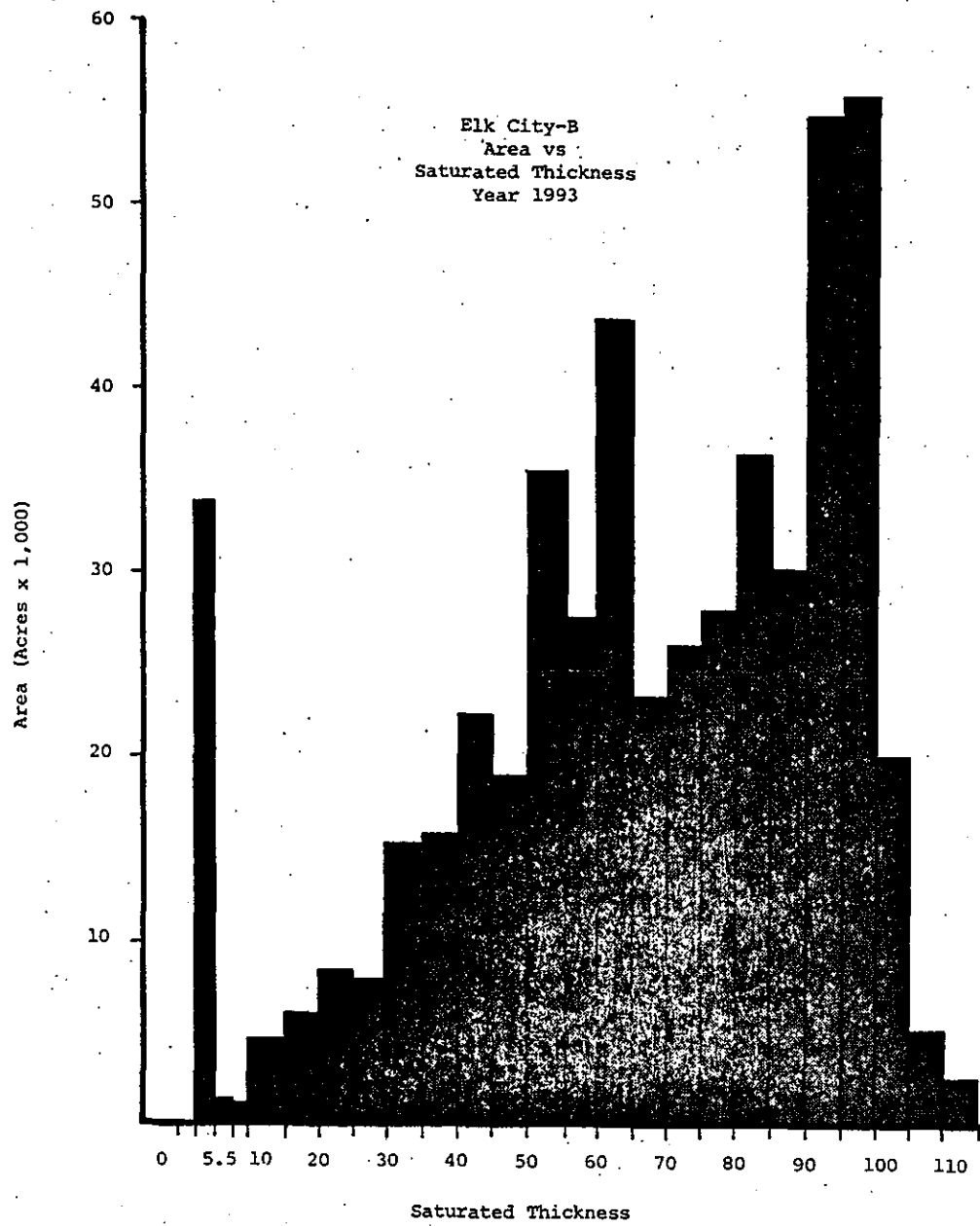

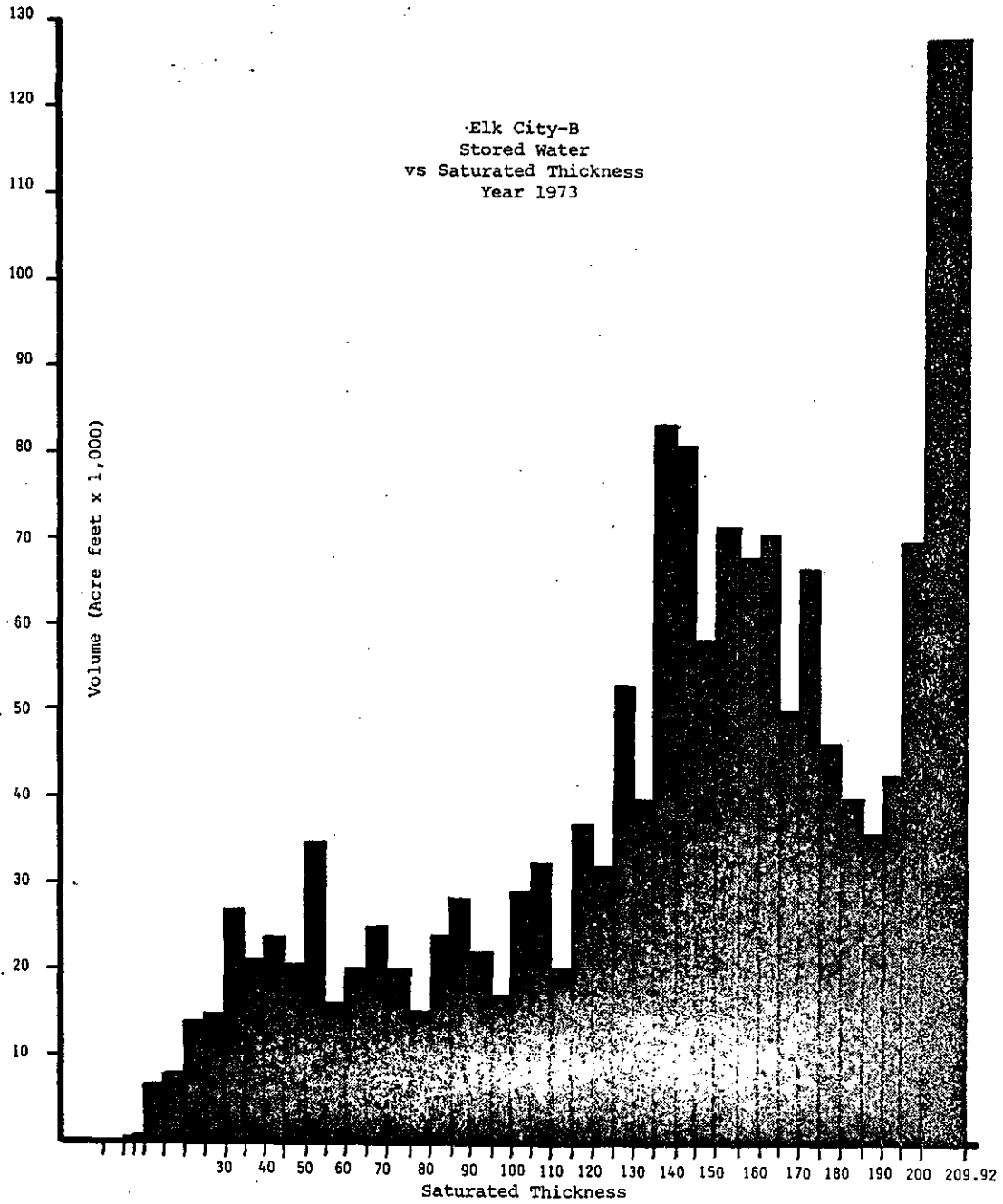

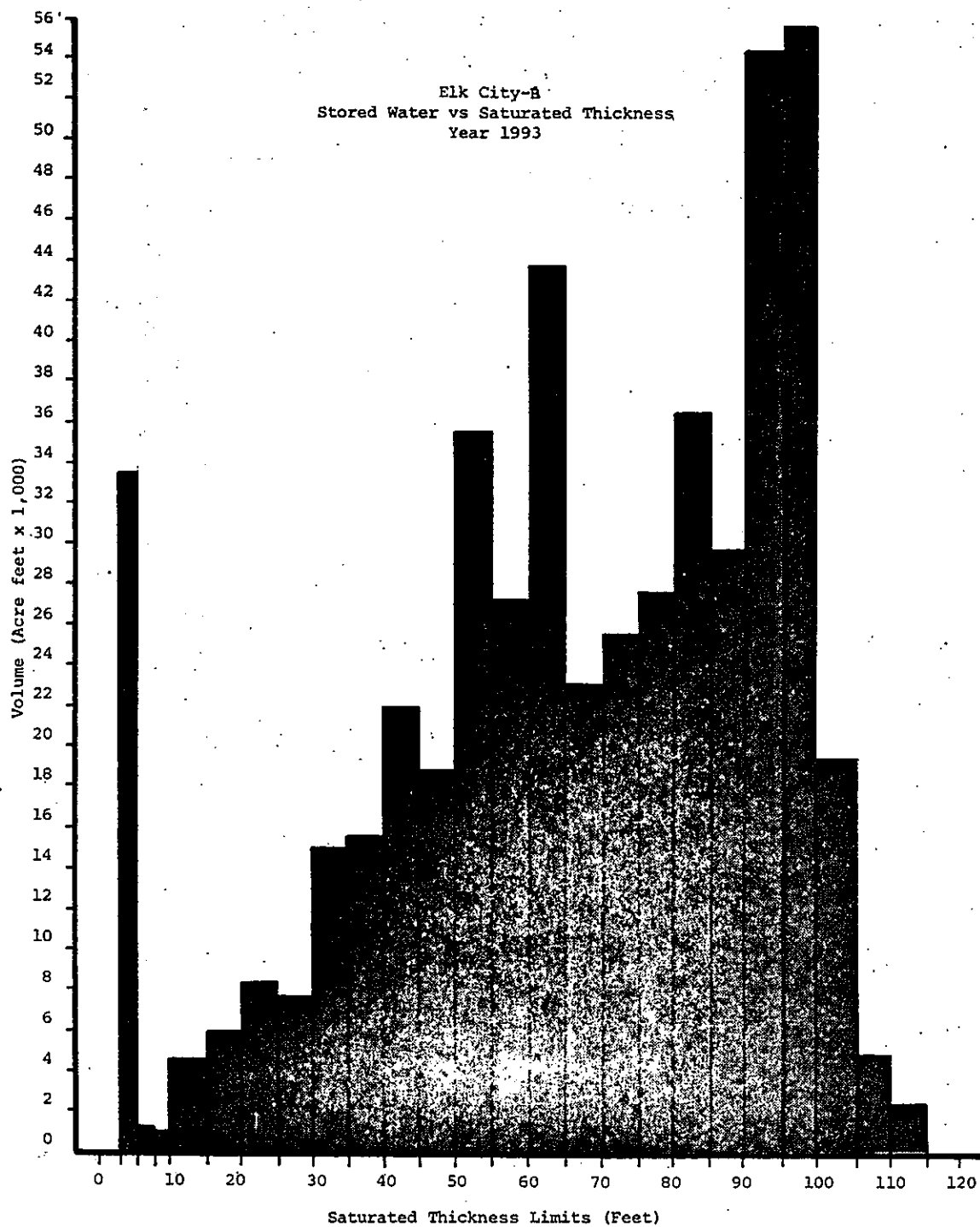

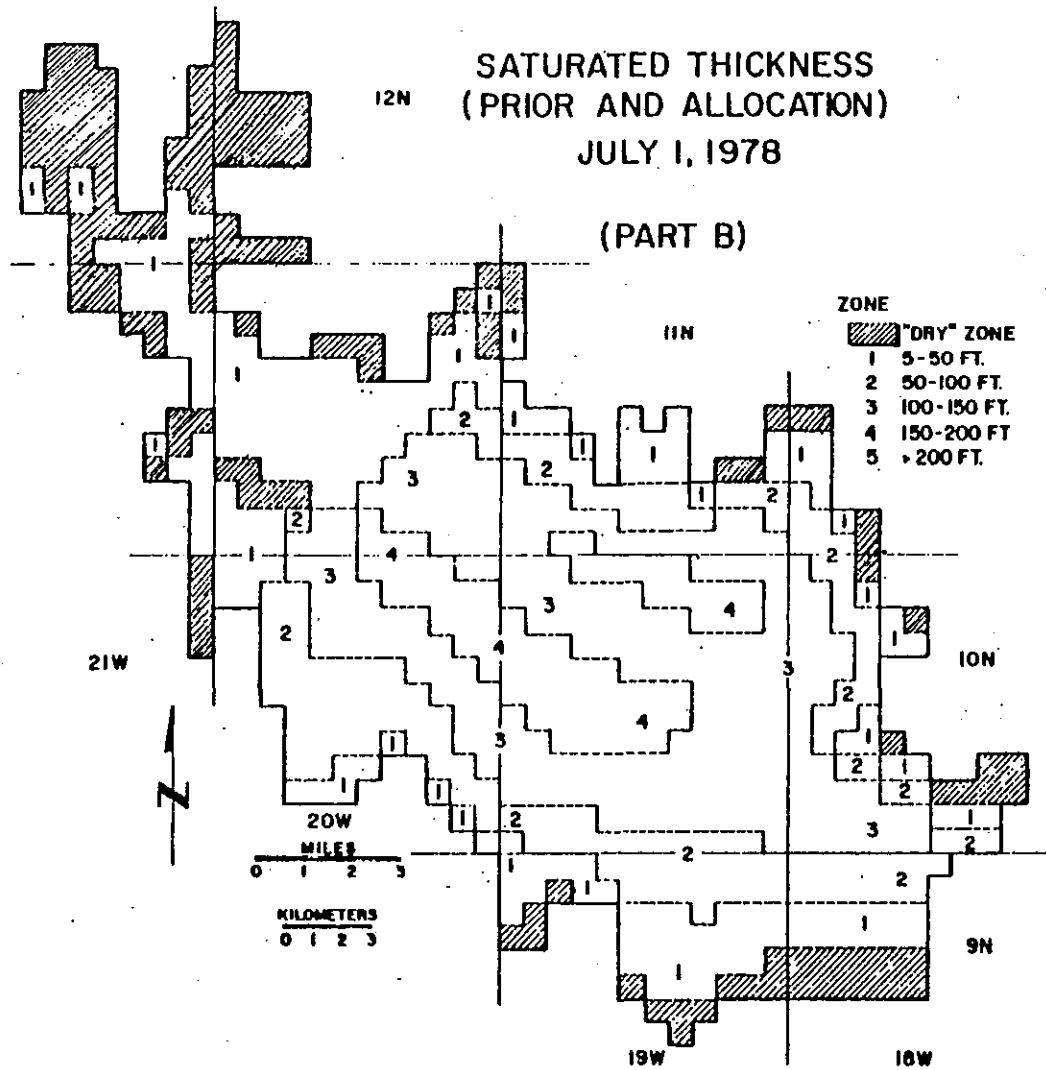
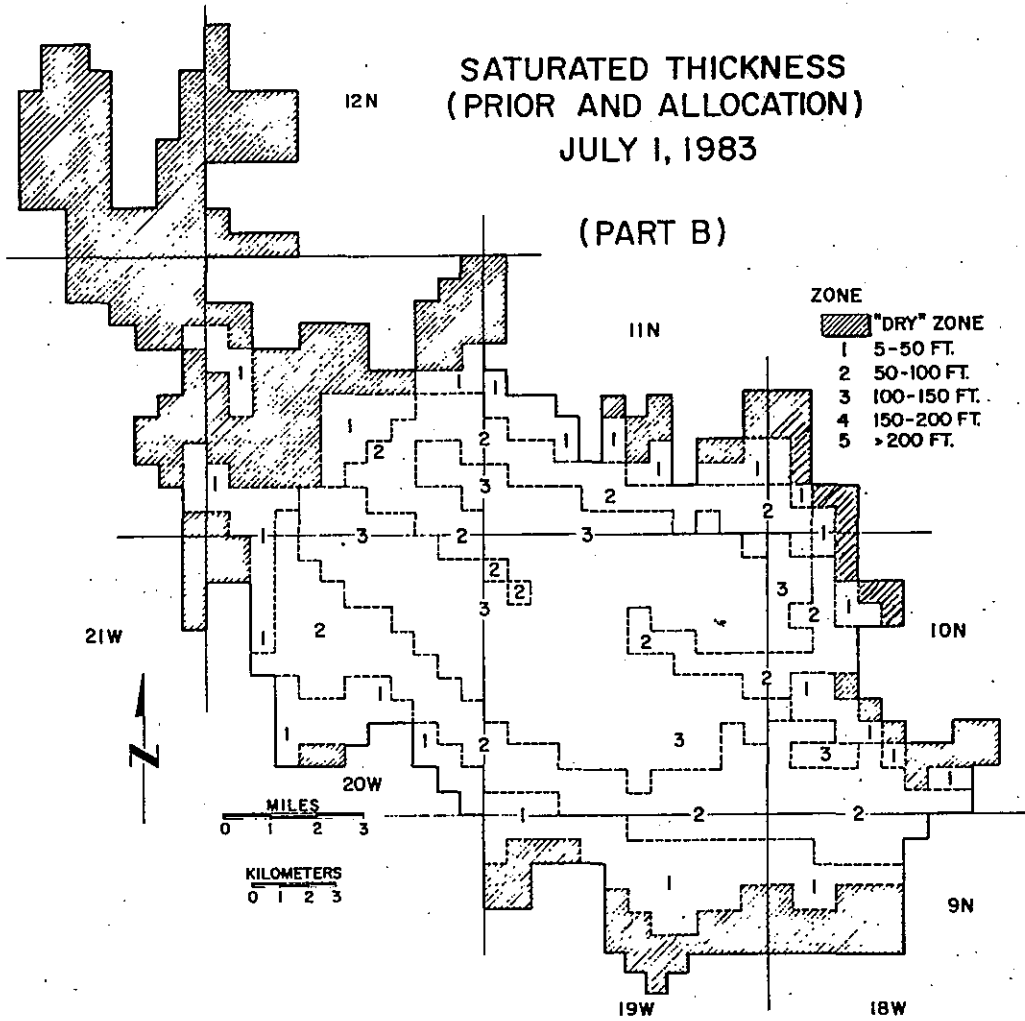

Figure 31. 1978 saturated thickness map (irrigation allocation)
(Part B)

SATURATED THICKNESS
(PRIOR AND ALLOCATION)
JULY 1, 1983

(PART B)



SATURATED THICKNESS
(PRIOR AND ALLOCATION)
JULY 1, 1988

(PART B)

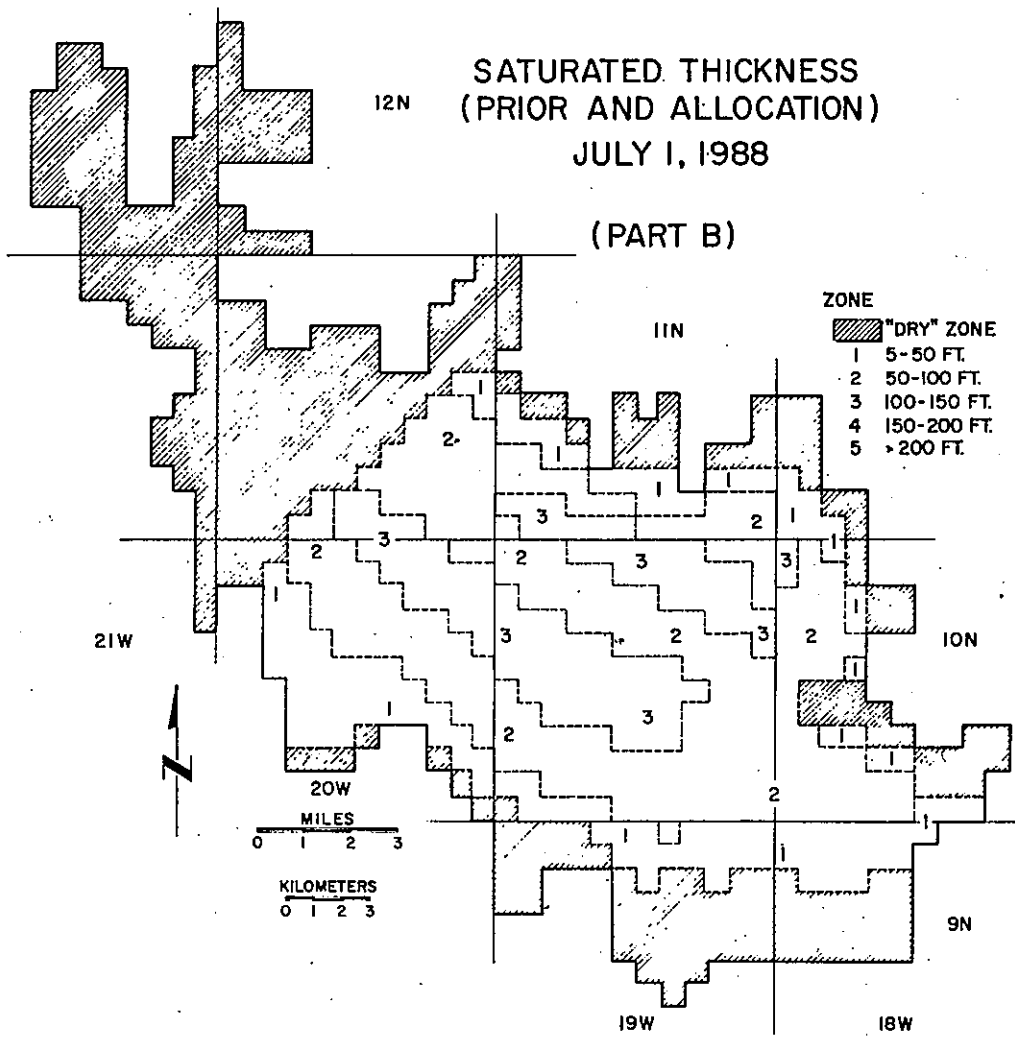

TRANSMISSIVITY
(PRIOR AND ALLOCATION)
JULY 1, 1993

(PART B)

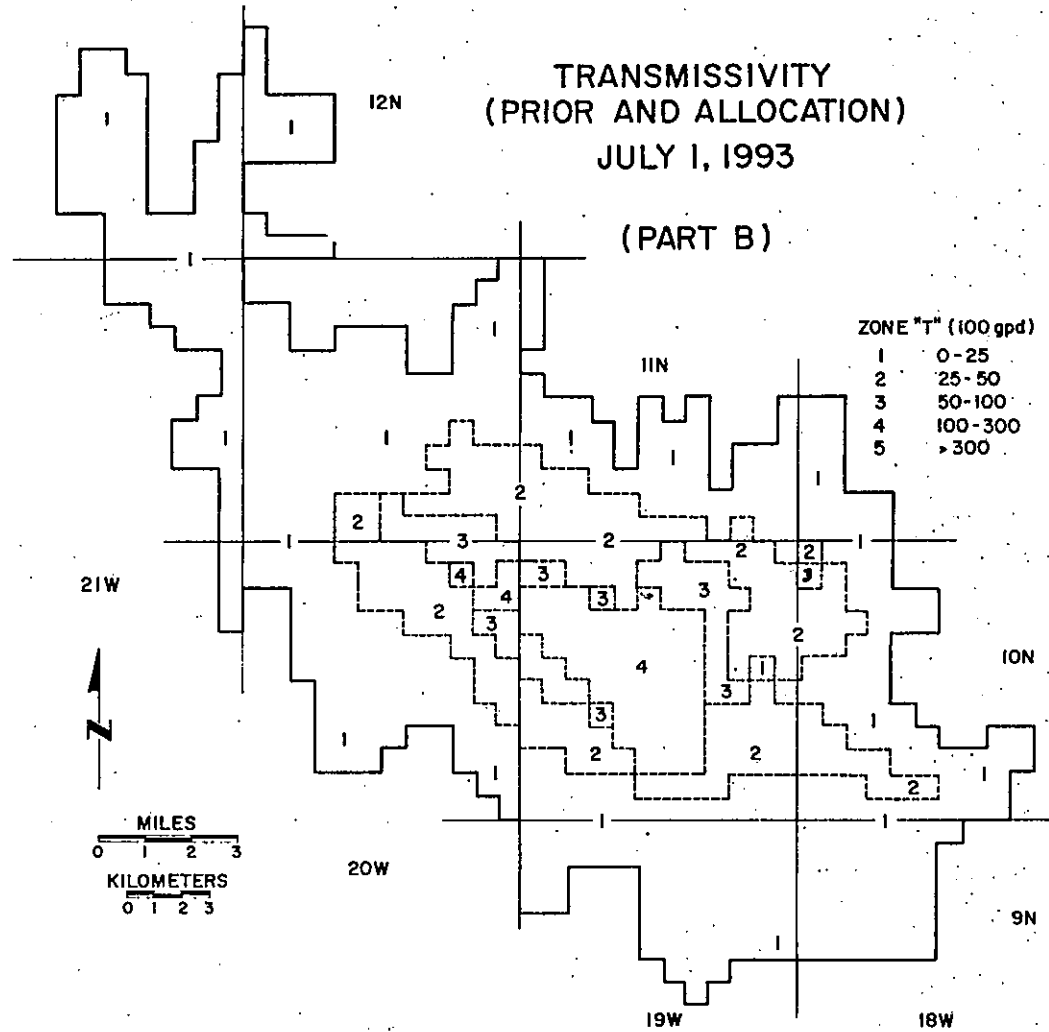

ELK CITY - PART B
WATER DEPTH ZONES
JULY 1, 1973

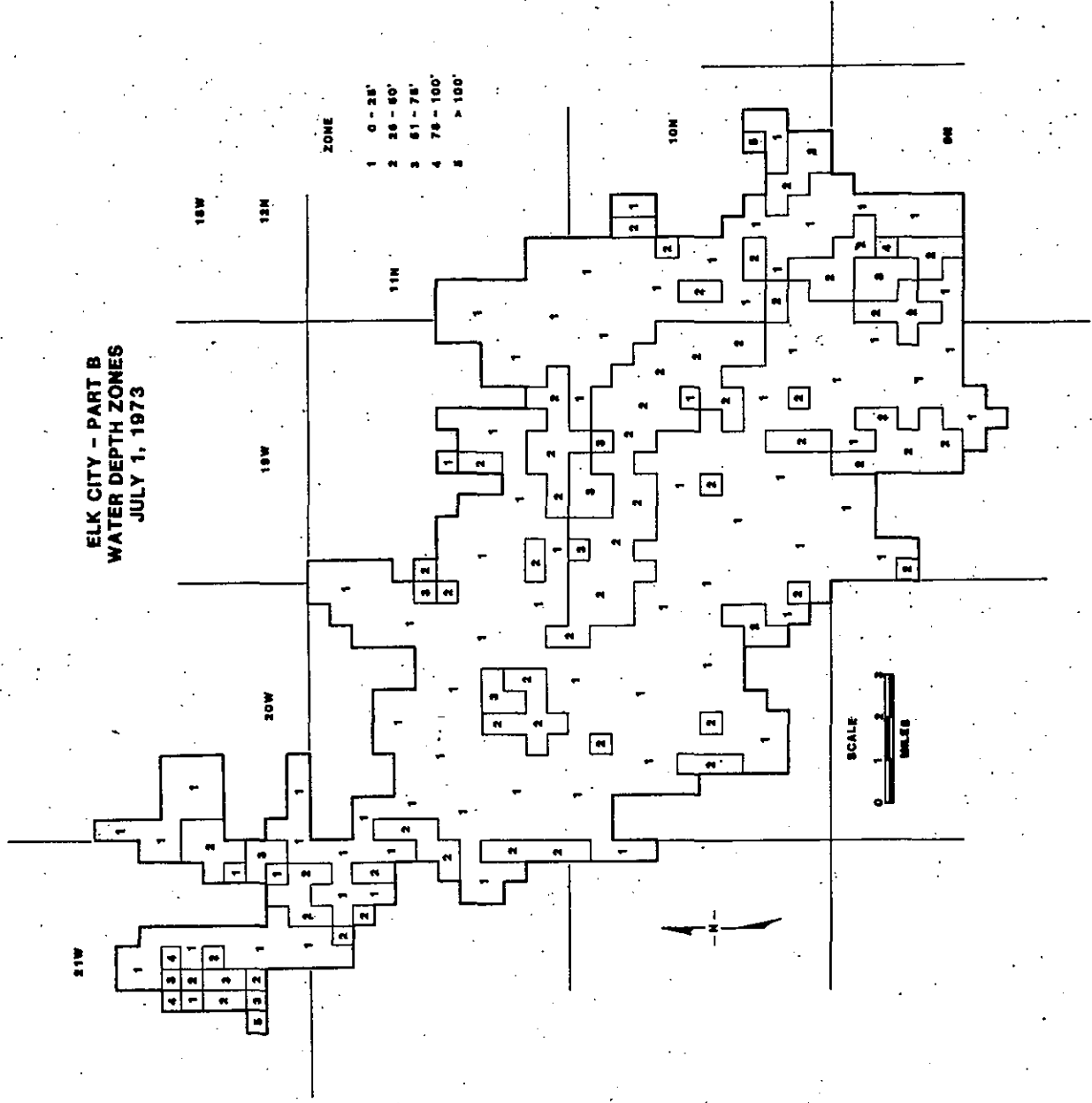

ELK CITY - PART B
WATER DEPTH ZONES
JULY 1, 1993

